

# 5300 Series

DIGITAL/ANALOG MOBILE RADIO

## OPERATING MANUAL

### 5300 SERIES MOBILE RADIO

- APCO Project 25 Conventional
- APCO Project 25 Trunked
- SMARTNET<sup>®</sup>/SmartZone<sup>®</sup>
- Analog FM Conventional

**VHF**

**UHF**

**700/800 MHz**

**Part No. 242-53xx-xxx**



December 2004

Part Number: 002-5300-010CD

Supersedes: 002-5300-009; 5/04



# 5300 SERIES MOBILE OPERATING MANUAL

- APCO PROJECT 25 CONVENTIONAL
- APCO PROJECT 25 TRUNKED
- SMARTNET®/SmartZone®
- ANALOG (FM) CONVENTIONAL

## VHF, UHF, 700/800 MHz, 800 MHz

Copyright© 2004 by the E.F. Johnson Company

The E.F. Johnson Company, which was founded in 1923, provides wireless communication systems solutions for public safety, government, and commercial customers. The company designs, manufactures, and markets conventional and trunked radio systems, mobile and portable subscriber radios, repeaters, and Project 25 digital radio products. EFJohnson is a wholly owned subsidiary of EFJ, Inc.

Viking Head/EFJohnson logo and Call Guard® are trademarks of the E.F. Johnson Company. SMARTNET®, SmartZone®, SecureNet™, Call Alert™, Enhanced Private Conversation™, and Private Conversation II™ are trademarks of Motorola, Inc. All other company and/or product names used in this manual are trademarks and/or registered trademarks of their respective manufacturer. The IMBE™ voice coding technology embodied in this product is protected by intellectual property rights including patent rights of Digital Voice Systems, Inc.

**LAND MOBILE PRODUCT WARRANTY** - The manufacturer's warranty statement for this product is available from your product supplier or from E.F. Johnson Company, 1440 Corporate Drive, Irving, TX 75038-2401. Phone (800) 328-3911.

Information in this manual is subject to change without notice.

Covers 53xx firmware through Versions 1.28/2.6/3.6/4.2, PCConfigure software through Version 1.26

## RF ENERGY EXPOSURE AWARENESS AND CONTROL INFORMATION, AND OPERATIONAL INSTRUCTIONS FOR FCC OCCUPATIONAL USE REQUIREMENTS

**Before using your mobile two-way radio, read this important RF energy awareness and control information and operational instructions to ensure compliance with the FCC's RF exposure guidelines.**

*NOTICE: This radio is intended for use in occupational/controlled conditions, where users have full knowledge of their exposure and can exercise control over their exposure to meet FCC limits. This radio device is NOT authorized for general population, consumer, or any other use.*

This two-way radio uses electromagnetic energy in the radio frequency (RF) spectrum to provide communications between two or more users over a distance. It uses radio frequency (RF) energy or radio waves to send and receive calls. RF energy is one form of electromagnetic energy. Other forms include, but are not limited to, electric power, sunlight and x-rays. RF energy, however, should not be confused with these other forms of electromagnetic energy, which when used improperly can cause biological damage. Very high levels of x-rays, for example, can damage tissues and genetic material.

Experts in science, engineering, medicine, health and industry work with organizations to develop standards for exposure to RF energy. These standards provide recommended levels of RF exposure for both workers and the general public. These recommended RF exposure levels include substantial margins of protection. All two-way radios marketed in North America are designed, manufactured and tested to ensure they meet government established RF exposure levels. In addition, manufacturers also recommend specific operating instructions to users of two-way radios. These instructions are important because they inform users about RF energy exposure and provide simple procedures on how to control it. Please refer to the following web sites for more information on what RF energy exposure is and how to control your exposure to assure compliance with established RF exposure limits.

<http://www.fcc.gov/oet/rfsafety/rf-faqs.html>  
<http://www.osha.gov/SLTC/radiofrequencyradiation/index.html>

### FEDERAL COMMUNICATIONS COMMISSION REGULATIONS

The FCC rules require manufacturers to comply with the FCC RF energy exposure limits for mobile two-way

radios before they can be marketed in the U.S. When two-way radios are used as a consequence of employment, the FCC requires users to be fully aware of and able to control their exposure to meet occupational requirements. Exposure awareness can be facilitated by the use of a label directing users to specific user awareness information. Your EFJohnson two-way radio has a RF exposure product label. Also, your EFJohnson user manual, or product manual, or separate safety booklet includes information and operating instructions required to control your RF exposure and to satisfy compliance requirements.

### COMPLIANCE WITH RF EXPOSURE STANDARDS

Your EFJohnson two-way radio is designed and tested to comply with a number of national and international standards and guidelines (listed below) regarding human exposure to radio frequency electromagnetic energy. This radio complies with the IEEE and ICNIRP exposure limits for occupational/controlled RF exposure environment at duty factors of up to 50% talk and 100% listen and is authorized by the FCC for occupational use. In terms of measuring RF energy for compliance with the FCC exposure guidelines, your radio antenna radiates measurable RF energy only while it is transmitting (during talking), not when it is receiving (listening) or in standby mode.

Your EFJohnson two-way radio complies with the following RF energy exposure standards and guidelines:

- United States Federal Communications Commission, Code of Federal Regulations; 47 CFR §§ 2 sub-part J.
- American National Standards Institute (ANSI) / Institute of Electrical and Electronic Engineers (IEEE) C95. 1-1992.
- Institute of Electrical and Electronic Engineers (IEEE) C95.1-1999 Edition.

### RF EXPOSURE COMPLIANCE AND CONTROL GUIDELINES AND OPERATING INSTRUCTIONS

To control exposure to yourself and others and ensure compliance with the occupational/controlled environment exposure limits always adhere to the following procedures.

Guidelines:

- User awareness instructions should accompany device when transferred to other users.
- Do not use this device if the operational requirements described herein are not met.

Instructions:

- Transmit no more than the rated duty factor of 50% of the time. To transmit (talk), push the Push-To-Talk (PTT) button. To receive calls, release the PTT button. Transmitting 50% of the time, or less, is important because this radio generates measurable RF energy exposure only when transmitting (in terms of measuring for standards compliance).
- Transmit only when people outside the vehicle are at least the recommended minimum lateral distance away, as shown in Table 1, from a properly installed according to installation instructions, externally-mounted antenna.

*NOTE: Table 1 lists the recommended minimum lateral distance for bystanders in an uncontrolled environment from transmitting types of antennas (i.e., monopoles over a ground plane, or dipoles) at several different ranges of rated radio power for mobile radios installed in a vehicle.*

**Table 1 Rated Power and Recommended Lateral Distance**

Rated Power of Vehicle-Installed Two-Way Radio	Recommended Minimum Lateral Distance From Transmitting Antenna
Up to 50 watts	1.0 meter
50-110 watts	1.5 meter

**MOBILE ANTENNAS**

- Install antennas at the center of the roof or the center of the trunk deck taking into account the bystander exposure conditions of backseat passengers and the recommended minimum lateral distances in Table 1. These mobile antenna installation guidelines are limited to metal body motor vehicles or vehicles with appropriate ground planes. The antenna installation should additionally be in accordance with:
  - a.) The requirements of the antenna manufacturer/supplier.
  - b.) Instructions in the Radio Installation Manual, including minimum antenna cable lengths.

c.) The installation manual should provide specific information of how to install the antennas to facilitate recommended operating distances to all potentially exposed persons.

- Use only EFJohnson approved supplied antenna or EFJohnson approved replacement antenna. Unauthorized antennas, modifications, or attachments could damage the radio and may violate FCC regulations. Antennas tested with EFJohnson radios are listed in Table 2.

**Table 2 Tested Antenna Whips and Bases (Antenna Manufacturer - Antenna Specialists)**

Frequency	Whip Model No.	Base Model No.
136-144 MHz	ASPJ1415	KM220
144-152 MHz	ASPA1415	KM220
152-162 MHz	ASPB1415	KM220
162-174 MHz	ASPC1415	KM220
400-430 MHz	ASPE1615	KM220
430-470 MHz	ASPD1615	KM220
470--512 MHz	ASPF1615	KM220
806-869 MHz	ASPA1855	KM220
890-960 MHz	ASPG1865	KM220

**APPROVED ACCESSORIES**

- This radio has been tested and meets the FCC RF exposure guidelines when used with the EFJohnson accessories supplied or designated for this product. Use of other accessories may not ensure compliance with the FCC’s RF exposure guidelines, and may violate FCC regulations.
- For a list of EFJohnson approved accessories, refer to the radio service manual or contact the E.F. Johnson Company as follows.

**CONTACT INFORMATION**

For additional information on exposure requirements or other information, contact the E.F. Johnson Company at the following address or telephone number:

Customer Service Department  
 E.F. Johnson Company  
 1440 Corporate Drive  
 Irving, TX 75038-2401

**Telephone Toll Free:** (800) 328-3911

TABLE OF CONTENTS

**SAFETY INFORMATION**

Federal Communications Commission Regulations 3  
 Compliance with RF Exposure Standards .....3  
 RF Exposure Compliance and Control Guidelines  
 and Operating Instructions .....3  
 Mobile Antennas .....4  
 Approved Accessories .....4  
 Contact Information .....4

**1 GENERAL**

1.1 Features .....8  
 1.2 General Features .....8  
     Conventional Features ..... 8  
     SMARTNET/SmartZone Features ..... 8  
     Project 25 Trunked Features..... 9

**2 CONTROLS AND DISPLAY**

2.1 Front Panel Controls .....10  
 2.2 Rear Panel Connectors.....11  
 2.3 Display.....11

**3 GENERAL OPERATION**

3.1 Turning Power On and Setting Volume .....13  
     Power ON/OFF ..... 13  
     Setting Volume Level ..... 13  
 3.2 Power-Up Password.....13  
     General ..... 13  
     Password Features With Later Models ..... 13  
     Password Features with Early Unrev. Models . 13  
 3.3 Backlight Control & Display Viewing Angle Adj 14  
 3.4 Zone/Channel Display and Select .....14  
     Zone/Channel Display ..... 14  
     Zone/Channel Select ..... 14  
     Direct Channel Select ..... 14  
 3.5 Setting Squelch Control.....15  
 3.6 Transmit Disable .....15  
 3.7 Radio Operating Modes.....15  
     General ..... 15  
     Conventional Mode..... 16  
     SMARTNET/SmartZone Mode ..... 16  
     P25 Trunked Mode ..... 16  
     Systems, Channels, and Zones ..... 17

**4 RADIO WIDE FEATURES**

4.1 Option Switches.....19  
 4.2 Time-Out Timer.....19

4.3 Home Zone-Channel Select ..... 19  
 4.4 Power Output Select ..... 19  
 4.5 Alert Tone Select ..... 19  
 4.6 Power Turn-Off Delay ..... 20  
 4.7 Horn Alert..... 20  
 4.8 Microphone Off-Hook Detect ..... 20  
 4.9 Surveillance Mode ..... 20  
 4.10 Public Address ..... 20  
 4.11 Scanning ..... 21  
     Introduction ..... 21  
     Priority (Standard) Scanning ..... 21  
     Radio Wide Scanning ..... 21  
     Scan Hold Time..... 22  
     Transmitting in the Scan Mode ..... 22  
     Nuisance Channel Delete..... 22  
 4.12 Scan Lists ..... 23  
     Priority Mode Scan Lists ..... 23  
     Radio Wide Scan List ..... 24

**5 CONVENTIONAL FEATURES**

5.1 Introduction ..... 25  
 5.2 Monitoring Before Transmitting ..... 25  
 5.3 Monitor Mode..... 25  
 5.4 Busy Channel Lockout ..... 26  
 5.5 Call Guard Squelch..... 26  
     Introduction ..... 26  
     Call Guard Squelch Enable/Disable ..... 26  
     Tone Call Guard Squelch..... 26  
     Digital Call Guard Squelch ..... 26  
     Selective Sq Code Select (CTCSS/DSC/NAC). 27  
 5.6 Penalty Timer ..... 27  
 5.7 Conversation Timer ..... 27  
 5.8 Repeater Talk-Around ..... 28  
 5.9 Displaying Transmit/Receive Frequency ..... 28  
 5.10 Emergency Alarm and Call ..... 28  
     Introduction ..... 28  
     Emergency Alarms ..... 28  
     Emergency Calls ..... 29  
 5.11 Conventional Mode Scanning ..... 29  
     General..... 29  
     Selecting a Scan List ..... 29  
     Transmitting in Scan Mode ..... 30  
     Priority Channel Sampling ..... 30  
 5.12 Standard Conventional Calls ..... 31  
 5.13 DTMF/ANI Signaling..... 32  
 5.14 Single Tone Encoder ..... 32  
 5.15 MDC1200 Compatibility ..... 32  
 5.16 Project 25 Mode Features..... 32  
     Unit ID Code ..... 32  
     Group ID Code ..... 32  
     Network Access Code (NAC)..... 33  
     P25 Group Calls..... 33

TABLE OF CONTENTS (CONT'D)

P25 Unit Calls . . . . .	33	Site Trunking . . . . .	49
P25 Conventional Telephone Calls . . . . .	34	Determining Current Site and Searching For a New Site . . . . .	49
Call Alert . . . . .	35	Locking/Unlocking a Site . . . . .	49
Messaging . . . . .	36	ZoneFail Site Lock . . . . .	49
Status Messaging . . . . .	36	P25 Wide Area Scan . . . . .	50
P25 Packet Data . . . . .	36		
5.17 Keypad Programming . . . . .	36	<b>7 MISCELLANEOUS</b>	
Introduction . . . . .	36	7.1 Supervisory Tones . . . . .	51
Menu Structure . . . . .	37	7.2 Error Messages . . . . .	52
Zone Password . . . . .	37	7.3 System Operator Programming . . . . .	53
Zone Change Parameter . . . . .	37	7.4 Speaking Into Microphone . . . . .	54
Channel Change Parameter . . . . .	37	7.5 Operation At Extended Range . . . . .	54
System Parameters . . . . .	38	7.6 Preventing Battery Discharge . . . . .	54
Channel Parameters . . . . .	38	7.7 Licensing . . . . .	54
		7.8 Radio Service . . . . .	54
<b>6 SMARTNET/SMARTZONE/P25 TRUNKED FEATURES</b>		<b>8 DETERMINING AVAILABLE OPTIONS</b>	
6.1 Introduction . . . . .	40	8.1 General . . . . .	55
6.2 Analog and Digital Operation . . . . .	40	8.2 Upgrading A Radio With New Options . . . . .	55
6.3 Viewing Unit ID . . . . .	40	8.3 Using PCConfigure To Determine Options . . . . .	55
6.4 Standard Group Calls . . . . .	40		
Introduction . . . . .	40	<b>9 5300 MOBILE FIRMWARE VERSIONS</b>	
Placing a Standard Group Call . . . . .	40	9.1 General . . . . .	57
Receiving a Standard Group Call . . . . .	40	9.2 53xx Radio Firmware Versions . . . . .	57
6.5 Private (Unit-To-Unit) Calls . . . . .	41	Version 1 (ARM) Radios . . . . .	57
General . . . . .	41	Version 2 and 3 (PPC) Radios . . . . .	57
Placing an Enhanced Private Conversation Call . . . . .	41	Version 4 (PPC) Radios . . . . .	57
Placing a Standard Private Conversation Call . . . . .	42	9.3 Determining Radio Version . . . . .	57
Receiving a Private Call (All Types) . . . . .	43	9.4 Programming Software Required . . . . .	57
6.6 Telephone Calls . . . . .	43		
General . . . . .	43	<b>10 PASSWORD DESCRIPTION</b>	
Placing a Telephone Call . . . . .	43	10.1 New Password Enhancements . . . . .	58
Receiving a Telephone Call . . . . .	44	Introduction . . . . .	58
6.7 Call Alert . . . . .	44	Software Versions Required . . . . .	58
6.8 Messaging . . . . .	45	Availability With Earlier Versions . . . . .	58
6.9 Sending Status Conditions . . . . .	45	10.2 Programming Passwords . . . . .	58
6.10 Emergency Alarm and Call . . . . .	45	General . . . . .	58
Introduction . . . . .	45	Lost Passwords . . . . .	58
Emergency Alarms . . . . .	46	Changing Passwords . . . . .	59
Emergency Calls . . . . .	46	Password Entry Procedure . . . . .	59
6.11 Failsoft Operation . . . . .	47	10.3 Password Description . . . . .	59
6.12 SMARTNET/SmartZone/P25 Trunked Scanning Features . . . . .	47	User (Power-On) Passwords . . . . .	59
General . . . . .	47	Download/Upload Passwords . . . . .	59
Priority Talk Group Sampling . . . . .	47	Master Password . . . . .	59
Scan List Editing and Selection . . . . .	48	10.4 Zone Password . . . . .	59
6.13 Dynamic Regrouping . . . . .	48		
6.14 SmartZone and P25 Trunking Unique Features . . . . .	48		
Introduction . . . . .	48		
Busy Override . . . . .	48		

TABLE OF CONTENTS (CONT'D)

<b>11</b>	<b>SECURE COMMUNICATION (ENCRYPTION)</b>		
11.1	General	60	Keysets..... 64
	Introduction.....	60	Crypto Groups..... 64
	Encryption Algorithms.....	60	Key Management Facility..... 65
	Encryption Available With Various Channel		Message Number Period (MNP)..... 65
	Types.....	60	Definitions..... 65
	5300 Encryption Capabilities.....	60	11.5 Radio Setup For Encryption..... 67
	FIPS and Non-FIPS Modes.....	61	General Encryption Setup..... 67
11.2	Encryption Keys	61	Additional Setup For OTAR..... 68
	Introduction.....	61	11.6 Radio OTAR Capabilities..... 69
	Key and Algorithm IDs.....	61	SEM 5100/5300, Standard 5100..... 69
	PID/SLN Key Management Modes.....	61	UCM Equipped 5300..... 69
	Maintaining Keys in Memory.....	62	OTAR Option Switches..... 69
	Encryption Key Select.....	62	
	Encryption Key Erase.....	62	
	Encryption Icon Operation.....	62	
11.3	Clear/Secure Strapping	63	
	Transmit Mode Options.....	63	
	Receive Mode Options.....	63	
	Talk Group Encryption override.....	63	
11.4	OTAR (Over-The-Air Rekeying)	64	
	Introduction.....	64	
	Encryption Key Types.....	64	
			<b>INDEX..... 71</b>

## SECTION 1 GENERAL

### 1.1 FEATURES

*NOTE: The availability of many of the following features is controlled by field programming and by what options were ordered. For example, encryption and some operating modes are optional. See the EFJohnson product description and Sections 8 and 9 for further details.*

### 1.2 GENERAL FEATURES

- The following operating modes are programmable:
  - Conventional analog and APCO P25
  - Trunked SMARTNET®/SmartZone® and APCO P25
- AES 256-bit FIPS 140-2 approved encryption available on P25/digital channels.
- DES/DES-XL 64-bit encryption available on analog channels, DES-OFB FIPS 140-2 approved encryption available on digital channels (see Section 11).
- This model has a black front panel bezel, and an “RS-5300” label on the right top of the front panel.
- Up to 16 zones with 16 channels each (256 channels total) are standard.
- Large liquid crystal display (LCD) with backlight
- Six programmable option switches
- Horn alert
- External public address
- Programmable power-off delay
- Each option button programmable with a different function for each operating mode (Conventional, SMARTNET/SmartZone, Trunked P25)
- Emergency calls for high priority system access
- Priority (standard) and Radio Wide scan modes with user programmable scan lists
- User selectable high and low power output
- Stealth mode
- Time-out timer
- Power up password to prevent unauthorized use.
- Programmable and user adjustable tone volume
- Programmable minimum volume level
- Operates on both wide and narrow band channels

#### 1.2.1 CONVENTIONAL FEATURES

- Up to 256 channels or talk groups programmable
- Repeater talk-around

- Carrier or Call Guard® (CTCSS/DCS) controlled squelch on analog channels, NAC and talk group IDs on P25 channels
- Normal/selective squelch selectable by option switch
- Monitor mode selectable by option switch
- Time out penalty and conversation timers
- Dual priority channel sampling when scanning (analog and digital channels)
- Busy channel lockout (transmit disable on busy)
- Unit calls on P25 channels
- Telephone calls on P25 channels with over dial (firmware 1.28/2.6/3.6/4.2 or later)
- Emergency alarms and calls to alert a dispatcher of an emergency condition (analog emergency available only with firmware 1.20/2.0/3.0/4.0 or later).
- ANI (Automatic Number Identification) on analog channels
- MDC 1200 ANI and Emergency Alert support (models with firmware 4.x only)
- Call Alert™ on P25 channels (send and receive pages)
- Predefined messages (up to 16) can be sent to a dispatcher (P25 mode only)
- Predefined status conditions (up to 8) can be sent to a dispatcher (P25 mode only)
- OTAR (Over-The-Air-Rekeying) compatible (P25 channels only).
- Keypad programming with password access (Federal Government users only)

#### 1.2.2 SMARTNET/SMARTZONE FEATURES

- Up to 256 talk groups programmable (channels select talk groups)
- Group, Enhanced Private Conversation™, standard Private Conversation, and Telephone calls
- Emergency alarms to alert a dispatcher of emergency conditions
- Emergency calls for high priority system access
- Failsafe operation on a predefined conventional channel if trunked system fails
- Priority group calls detected while listening to other group calls when scanning
- Call Alert™ (send and receive pages)
- Predefined messages (up to 16) can be sent to a dispatcher



- Predefined status conditions (up to 8) can be sent to a dispatcher
- Dynamic regrouping (dispatcher can automatically gather users on a channel to receive a message)
- Roaming (SmartZone only)

### 1.2.3 PROJECT 25 TRUNKED FEATURES

- Up to 256 talk groups programmable (channels select talk groups)
- Group and Unit Calls
- Telephone calls with overdialing (with firmware 1.28/2.6/3.6/4.2 or later).

- Emergency alarms to alert a dispatcher of emergency conditions
- Emergency calls for high priority system access
- Failsoft operation on a predefined conventional channel if trunked system fails
- Priority group calls detected while listening to other group calls when scanning
- Call Alert™ (send and receive pages)
- Predefined status conditions (up to 8) can be sent to a dispatcher
- Dynamic regrouping (dispatcher can automatically gather users on a channel to receive a message)
- Roaming

## SECTION 2 CONTROLS AND DISPLAY

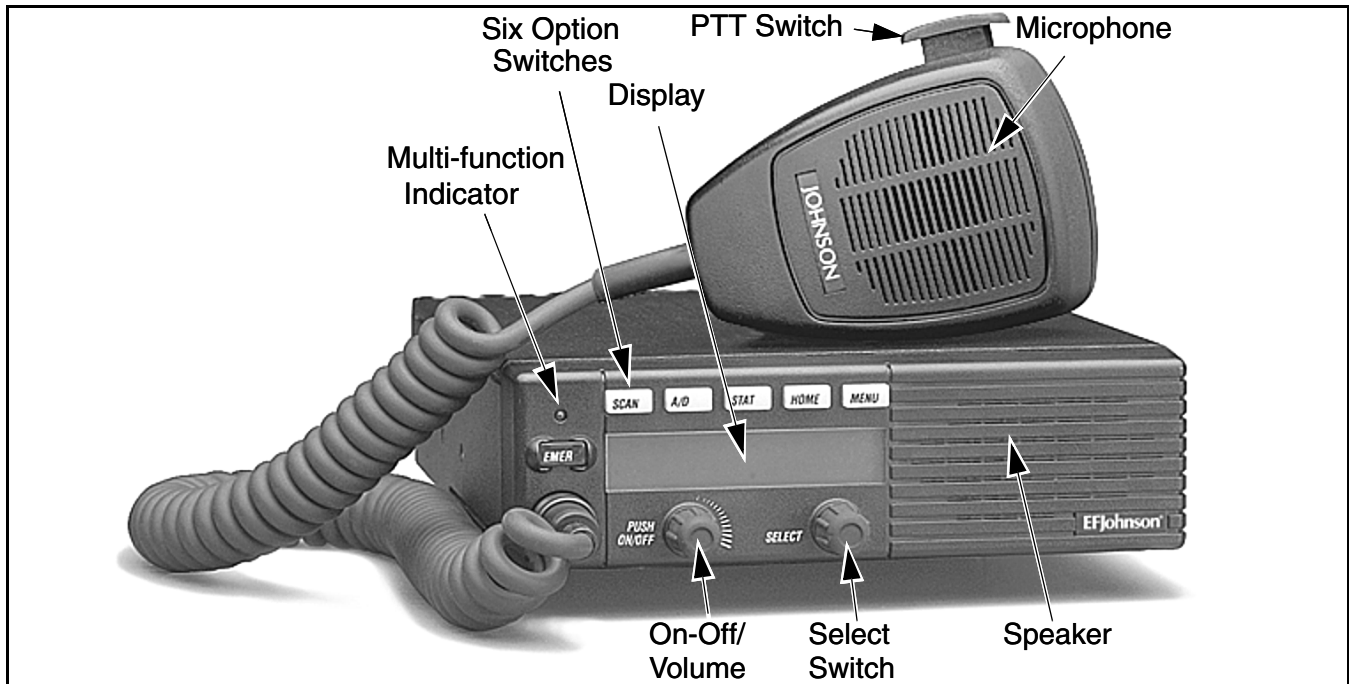

Figure 2-1 Front Panel Controls

## 2.1 FRONT PANEL CONTROLS

**On-Off/Volume** - Pressing this control turns power on and off, and rotating it sets the volume level.

**Select Switch** - Selects zones/channels and is also used for other functions such as selecting names from a call list. When selecting zones/channels, a bar above the zone or channel display (see Figure 2-3) indicates which is being changed. This bar is switched between displays by pressing this switch, and zone and channels are selected by rotating it (see “Zone/Channel Select” on page 14).

**Multi-function Indicator** - This is a two-color LED that indicates the following:

**Red (constant)** - Transmitter keyed (PTT switch pressed).

**Green (constant)** - Busy condition (carrier detected in receive mode).

*NOTE: This indicator is disabled when the Surveillance mode is programmed (see Section 4.9).*

**Option Switches** - Each of the six options switches on the front panel (including the one located to the left of the display) can be programmed by your system operator to control some function. The switch functions can be different for each operating mode (conventional, SMARTNET/SmartZone, and Project 25 Trunked). Therefore, up to 18 functions can be controlled by these switches. Refer to Section 4.1 for more information on option switch functions.

**Speaker** - An internal 16-ohm, 5-watt speaker is located behind the grille. An optional 4-ohm, 12-watt external speaker may be used if desired. The internal speaker is disabled when an external speaker is used.

**PTT Switch** - This push-button switch on the microphone is pressed to talk (key the transmitter) and released to listen.

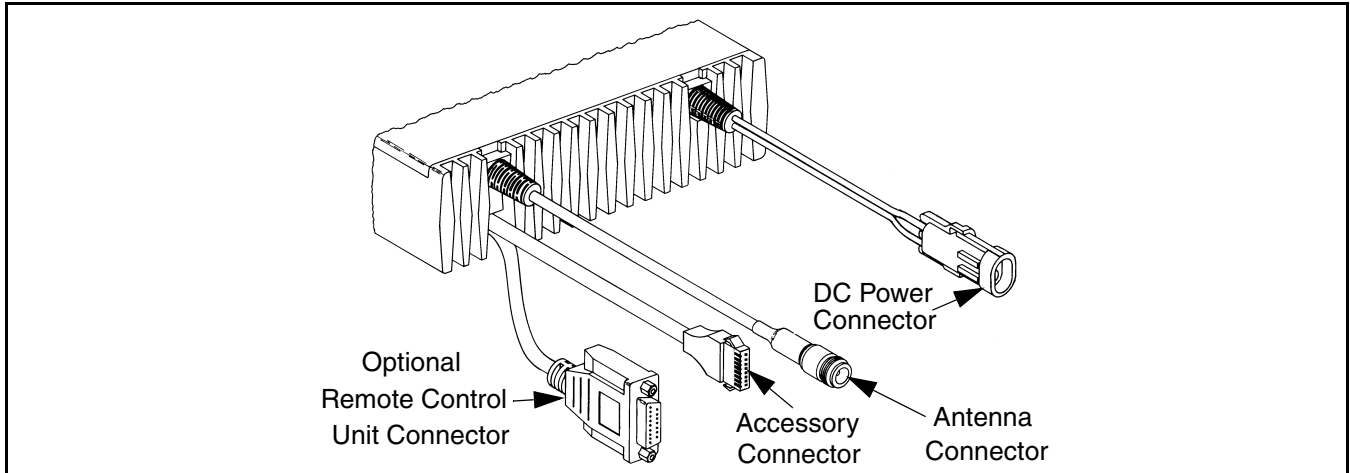

Figure 2-2 Rear Panel Connectors

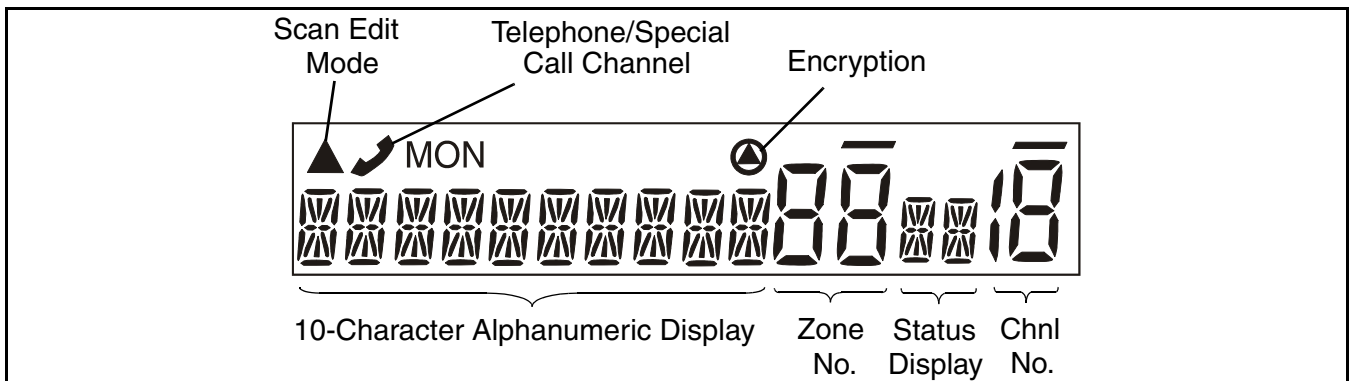

Figure 2-3 Front Panel Display

**2.2 REAR PANEL CONNECTORS**

**DC Power** - Connection point for the nominal 12-volt, negative ground power source (see Figure 2-2).

**Antenna** - Type N for connecting the antenna.

**Accessory** - Black connector for connecting optional accessories such as an external speaker (4-ohm, 12-watt), horn alert, and ignition sense line.

**Remote Control Unit** - Connection point for a remote control unit if used. This cable is optional with front-mount models.

**Data (Not Shown)** - An optional female DB9 jack for connecting external data equipment when the P25 Packet Data feature is used (see Section 5.16.10).

**Siren Control (Not Shown)** - An optional yellow/orange connector similar to the accessory jack for connecting the optional siren controller.

**2.3 DISPLAY**

**Alphanumeric Display** - This 10-character area of the display indicates the alias (unique identification) for the selected zone or channel, depending on which select mode is active. It may also indicate such things as the channel frequency, ID numbers, and status and error messages.

**Zone Number** - Indicates the currently selected zone from 1 up to 16. A zone is a collection of channels that can be any combination of the conventional, P25 Trunked, and SMARTNET/SmartZone types.

**Channel Number** - Indicates the currently selected channel (conventional) or talk group (other modes).

**Status Display** - These two characters indicate the following status information:

 - This symbol in the left position indicates that the displayed channel is in the scan list (scanned normally).

 - A "P" in the left position indicates that the selected conventional channel is a priority channel (first priority with dual priority).

 - A "2" in the left position indicates that the selected conventional channel is a second priority channel.

 - This rotating clock-like symbol in the right position indicates that scanning is enabled.

 - Indicates that the scan list edit or keypad programming mode is selected (see Section 4.12 or Section 5.17).

 - Indicates a telephone (interconnect) call has been initiated.

 - Indicates that voice encryption is enabled or that an encrypted call is being received. This indication flashes when an encrypted call is received on a digital channel. Refer to Section 11.2.7 for more information.

**MON** - Indicates that the conventional monitor mode is enabled by taking the microphone off-hook or pressing the **MON** option switch. This disables squelch control features so that all messages on the channel are heard. Refer to Sections 5.2 and 5.3 for more information. The radio can also be programmed so that this indication is displayed when the Normal mode is selected by the Normal/Selective function (see Section 5.5.2).

 - The lines above the zone and channel displays indicate which display is changed if the Select switch is turned. To switch between displays, press the Select switch (see Section 3.4.2).

## SECTION 3 GENERAL OPERATION

### 3.1 TURNING POWER ON AND SETTING VOLUME

#### 3.1.1 POWER ON/OFF

Power is turned on and off by pressing the On-Off/Volume knob. When power is turned on, the radio goes through a self test. When that is successfully completed, the unit ID is briefly displayed (except when a conventional analog channel is selected), a tone sounds (if tones are enabled), and the radio is ready for normal operation. If “ENTER PSWD” is briefly displayed, refer to the next section.

The radio can be programmed\* so that one of the following combinations are selected at power up:

- Last Zone/Last Channel
- Last Zone/Home Channel
- Home Zone/Last Channel
- Home Zone/Home Channel

The Home Zone and Channel are preprogrammed. With the “Last Zone”/“Home Channel” configuration, the programmed home channel number of the last active zone is selected. If this channel number is not programmed in the active zone, “Unprogram” is displayed. With earlier models, the last selected channel is displayed when powering up on the last selected zone, and the home channel is displayed when powering up on the home zone.

*NOTE: In dual control configurations (front mount radio with remote control unit), the power switches at both control points must be off for power to turn off.*

#### 3.1.2 SETTING VOLUME LEVEL

The relative volume setting can be determined using a reference tone as follows:

- If the key press tones are enabled (see Section 4.5 on page 19), a short tone sounds when an option switch is pressed or the Select switch is pressed or rotated.

- If a conventional channel is selected, take the microphone off-hook and if someone is talking, voice may be heard. If the MON (Monitor) option switch is programmed (see Section 5.3 on page 25), pressing it unscelches the radio and either voice or background noise is heard. If a SMARTNET/SmartZone or P25 trunked channel is selected, the radio cannot be manually unscelched.

### 3.2 POWER-UP PASSWORD

#### 3.2.1 GENERAL

The power-up password feature prevents unauthorized use of the radio by requiring that an 8-digit password be entered to make it operational. This feature is enabled or disabled by programming.

When it is enabled, “ENTER PSWD” is briefly displayed when power is turned on, the eight-digit numeric password must be entered by pressing and rotating the Select switch. If an incorrect password is entered, “INCORRECT” is displayed and it must be re-entered.

#### 3.2.2 PASSWORD FEATURES WITH LATER MODELS

With later revised models (with firmware 1.24.1/2.2.1/3.2.1 or later), an enhanced password scheme allows up to four power-on (user) passwords, download and upload passwords, and a master password to be programmed.

The current User password can be changed if the “PW CHG” option switch is programmed. Selecting this function displays prompts for entering and confirming a new password. Refer to Section 10 for more information on passwords.

#### 3.2.3 PASSWORD FEATURES WITH EARLY UNREVISED MODELS

With early unrevised models (with earlier firmware than listed above), only one power-on password is available, and it cannot be changed by the user. This

\* This feature requires radio firmware 2.2.1/3.2.1 or (ARM) 1.24.1 or later.

password must also be entered whenever programming data is read or written using the PCConfigure software. If this password is lost, all personality information must be erased using the PCTune software and the radio reprogrammed. Refer to Section 10 for more information on passwords.

### 3.3 BACKLIGHT CONTROL AND DISPLAY VIEWING ANGLE ADJUST

If the BKLHT option switch is programmed, it can be used to select high, medium, or off backlight modes. Otherwise, the keypad and display backlight is fixed in one of these modes by programming. The backlight is totally disabled when the Surveillance mode is programmed (see Section 4.9).

If the display is difficult to read from the angle you normally view it, the viewing angle can be adjusted as follows: Press and hold the last option switch above the display and then press the first option switch above the display. Then release both switches and turn the Select switch until the best contrast is obtained. This function times out in 3-5 seconds.

*NOTE: If the display appears blank or all icons are continuously displayed, the viewing angle is probably improperly adjusted.*

### 3.4 ZONE/CHANNEL DISPLAY AND SELECT

#### 3.4.1 ZONE/CHANNEL DISPLAY

The selected zone and channel numbers are displayed by the zone and channel displays shown in the following illustration. In addition, the selected zone identification (alias) is displayed in the alphanumeric display area when the zone select mode is enabled, and the channel alias is displayed when the channel select mode is enabled (see following). With conventional channels, the channel frequency may be displayed instead of the alias if the Display Information option switch is programmed (see Section 5.9).

A zone can include any mix of up to 16 channels, and up to 16 zones can be programmed. Therefore, up to 256 channels can be selected. One use for zones may be for operation in different geographical areas.

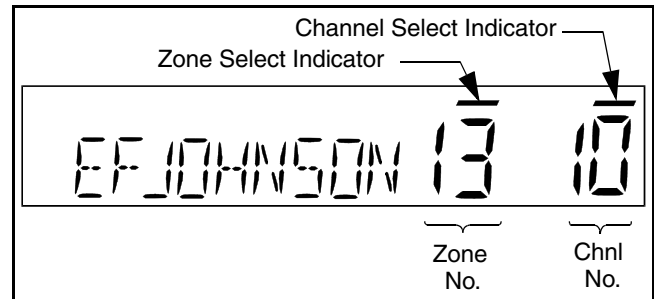

#### 3.4.2 ZONE/CHANNEL SELECT

The front panel Select switch is used to change the zone and channel. Pressing this switch toggles between the zone and channel select modes, and rotating it changes the zone or channel.

The current mode is indicated by the bar over the zone or channel display. For example, when the bar is over the zone display (see following illustration), the zone select mode is enabled.

Rotating the Select switch clockwise increases the zone or channel and rotating it counterclockwise decreases the zone or channel number. After the highest zone or channel is displayed, wrap-around to the lowest zone or channel occurs and vice versa. If an unprogrammed channel is selected, “UNPROGRAMD” is displayed and a tone sounds. The radio may also be programmed so that only programmed channels are selected.

The radio can be programmed so that the bar defaults to either the zone or channel display when power is turned on and after a change is made. The delay that occurs before it returns is programmed for 1-15 seconds. It can also be programmed to remain in the last selected mode.

#### 3.4.3 DIRECT CHANNEL SELECT

The direct Channel Select feature is available with the HHC\* (Handheld Control Unit) only, and if the Channel Select option switch parameter is programmed. This feature allows channels to be directly selected using the HHC numeric keys or Up/Down switch.

For direct selection purposes, channels are numbered sequentially starting with the lowest zone. Each zone can be programmed with up to 16 channels, so Zone 1 channels are numbered 1-16, Zone 2 channels 17-32, and so on as shown below. For example, Zone 1/Channel 16 is selected by Channel 16, and Zone 2/Channel 16 is selected by Channel 32.

Seq. Ch. No.	Zone	Channel
1 ↓ 16	1	1 ↓ 16
17 ↓ 23	2	1 ↓ 16
33 ↓	3	1 ↓

Proceed as follows to select channels using this mode:

1. Enable the direct Channel Select mode by pressing the Channel Select option switch. The alias and sequential number of the current channel are alternately displayed.
2. Select the desired channel using the Up/Down keys or directly enter it using the 0-9 keys. If using the 0-9 keys, the radio attempts to display the entered number after the 3rd digit is entered or approximately 2 seconds after the last key is pressed.
3. To exit this mode and select the entered channel, press the Channel Select switch again. This mode is also exited automatically without changing the channel after approximately 1 minute of no activity.

*NOTE: The Channel Select function should probably not be assigned to a number key because pressing that key to select a channel then exits the select mode.*

Other features of this mode are as follows:

- When using the Up/Down keys, wrap-around to the lowest zone/channel occurs after the last channel in

the highest programmed zone is displayed and vice versa. For example, if Zone 1/Channel 5 is the highest programmed channel, wrap-around occurs after Zone 1/Channel 16 is displayed.

- When an unprogrammed channel is displayed, the sequential channel number and “Unprogramd” are alternately displayed.
- If an invalid channel number is entered using the 0-9 keys, or the Channel Select option switch is pressed with “Unprogramd” displayed, an error tones sounds, “Invalid” is briefly displayed, and the displayed channel does not change.

### 3.5 SETTING SQUELCH CONTROL

This radio does not have a squelch control. The squelch level is preset and usually does not require readjustment. However, if the squelch level needs to be changed on a conventional analog channel, it can be changed using keypad programming if available (see Section 5.17 on page 36).

### 3.6 TRANSMIT DISABLE

Transmitting can be disabled on each conventional, SMARTNET, SmartZone, and P25 Trunked channel so that the channel is monitor-only. When transmitting is attempted on a receive-only channel, “Rx Only” is displayed and an error tone sounds. With the SMARTNET/SmartZone and P25 Trunked modes, this feature is available only with firmware 1.24.1/2.2.1/3.2.1 or later and PCConfigure software 1.22.0 or later.

### 3.7 RADIO OPERATING MODES

#### 3.7.1 GENERAL

Each selectable channel can be programmed for the conventional (analog or Project 25 digital), SMARTNET/SmartZone, or Project 25 digital trunked operating mode. For example, Zone 1/Channel 1 could be a conventional channel, Zone 1/Channel 2 a SMARTNET channel, and so on. More information on these modes follows.

### 3.7.2 CONVENTIONAL MODE

This is a non-trunked operating mode which accesses independent radio channels. There is no automatic access to several channels. Selecting a conventional channel selects a transmit and receive frequency and other channel parameters such as squelch control coding.

Conventional channels can be either standard (analog) or Project 25 (digital). With digital operation, the DSP (Digital Signal Processor) converts the audio signal to digital data which is sent over the air as complex tones. Another difference is that analog channels use Call Guard (CTCSS/DCS) squelch control and Project 25 channels use a NAC (Network Access Code) and talk group ID codes.

With Project 25 operation, a NAC is transmitted and it must match the NAC programmed in the base equipment and the mobile(s) being called for communication to occur. In addition, to receive standard group calls, the receiving mobile must be programmed to detect the transmitted talk group ID code.

With conventional operation, a busy channel condition is detected automatically if the busy channel lockout (transmit disable on busy) feature is programmed. Otherwise, it must be detected manually. An out-of-range condition is not indicated by special tones or messages as with SMARTNET operation because there is no initial data exchange with the repeater that allows this condition to be detected. Operating features unique to conventional channels are described in Section 5.

### 3.7.3 SMARTNET/SMARTZONE MODE

This is a trunked operating mode in which automatic access is provided to several RF channels. ID codes are used to select what mobiles are being called and what calls are received. Monitoring is performed automatically and special messages and tones indicate busy and out-of-range conditions.

SMARTNET and SmartZone operation and programming is very similar. Basically, SMARTNET operation is limited to a single repeater site and SmartZone operation allows automatic roaming between sites. Enhanced SMARTNET/SmartZone features

include roaming (SmartZone only), telephone, private, and emergency calls, Call Alert™, and messaging. Either analog or digital signaling may be used.

When a SMARTNET or SmartZone channel is selected or the radio is powered up on one of those channels, it searches for a control channel. Once a control channel is found, the alias (name) of the selected channel is displayed and the radio attempts to register on the radio system. If a control channel could not be found (because of an out of range condition or the system ID is not correct, for example), “NO SYS” (early units) or “Out Rnge” (later units) is displayed and the radio continues to search for a control channel.

The control channel transmits and receives system information to and from all radios registered on the system. Therefore, once a control channel is found, it is continuously monitored for incoming call information and is used to make call requests. The radio automatically changes to a traffic channel to place and receive calls and then returns to the control channel when the call is complete. Operating features unique to SMARTNET/SmartZone channels are described in Section 6.

### 3.7.4 P25 TRUNKED MODE

The P25 Trunked operating features are very similar to the SmartZone type just described. Since SmartZone features are also similar to SMARTNET features, all three modes are described in Section 6. Some differences between the P25 Trunking and SmartZone modes are as follows:

- Digital signaling is always used with P25 calls. Either analog or digital signaling may be used for SmartZone calls.
- Calls made to a specific mobile in the P25 mode are called Unit Calls. In the SMARTNET/SmartZone mode they are called Private Calls.
- Messaging is not available with P25 calls.
- Telephone calls are available in this mode with firmware 1.28/2.6/3.6/4.2 or later.
- The P25 control channel data rate is 9600 baud and the digital voice data rate is also 9600 baud. With



SmartZone operation, the control channel data rate is 3600 baud (both digital and analog calls) and the narrowband digital voice data rate is 9600 baud.

- The P25 mode uses a system ID, Wide Area Communications Network (WACN) ID, and RF Subsystem ID (RFSS). The SmartZone mode does not use the WACN and RFSS IDs.
- P25 Unit IDs can be 1-16,777,215 (000001-FFFFFF hex) and SmartZone Unit IDs can be 1-65,535 (0001-FFFF hex).

### 3.7.5 SYSTEMS, CHANNELS, AND ZONES

A zone and channel are selected to place and receive calls. The following describes the relationship between systems, channels, and zones.

#### Systems

A system is a collection of channels or talk groups belonging to the same repeater site. It defines all the parameters and protocol information required to access a site. Up to 16 systems of any type can be programmed.

The maximum number of channels assignable to a system is limited to 256. Channels may also be limited by available memory space as described in the following information.

#### Channels

A channel selects a radio (RF) channel or talk group as follows:

**Conventional Analog Mode** - A channel selects a specific radio channel, Call Guard (CTCSS/DCS) squelch coding, and other parameters unique to that channel.

**Conventional Project 25 Mode** - A channel selects a specific radio channel, NAC squelch coding, talk group ID, and other parameters unique to that channel.

**SMARTNET/SmartZone and Trunked Project 25 Modes** - A channel selects a specific talk group, announcement group, emergency group, and other parameters unique to that talk group.

A maximum of up to approximately 256 channels can be programmed with the preceding modes. These channels can belong to a single system or multiple systems. The maximum number is also limited by the available memory. For example, since more memory is required to program a SMARTNET system than a conventional system, the total number of channels decreases as the number of SMARTNET channels increases. The programming software displays a bar graph which shows the amount of available memory space that is used by the current data.

#### Zones

A zone is a collection of up to 16 channels of any type. For example, a zone could include 12 conventional channels and 4 SMARTNET channels. One use of zones may be to program the channels used for operation in a different geographical areas. The maximum number of zones is 16.

## SECTION 4 RADIO WIDE FEATURES

Table 4-1 Programmable Option Switch Functions

Suggested Key Label	Function	Available in Mode:				See Descript. in Section:
		Conv.	Proj 25 Trk	SMARTNET	SmartZone	
TONES	Alert tones On-Off	X	X	X	X	4.5
BKLHT	Backlight On-Off	X	X	X	X	3.3
ALERT	Call Alert Select	X	X	X	X	6.7
RESP	Call Response Select		X	X	X	6.5.4
	Cancel Dynamic Regroup		X	X	X	6.13
KY CHG	Change Keyset	X	X	X	X	11.6.3
CH SEL	Channel Select (w/HHC only)	X	X	X	X	3.4.3
C/S	Clear/Secure Select	X	X	X	X	11.3
	Display GPS (future feature)	X				
TG SEL	Digital Talk Group Select	X				5.16.4
DISP	Display Information Select	X				5.9
EMER	Emergency Select	X	X	X	X	5.10, 6.10
KY CLR	Erase Keys	X	X	X	X	11.2.6
PUB AD	External Public Address	X	X	X	X	4.10
TX PWR	High/Low Tx Power Select	X	X	X	X	4.4
HOME	Home Zone Select	X	X	X	X	4.3
HORN	Horn Honk Select	X	X	X	X	4.7
KY SEL	Key Select	X				11.2.5
PROG	Keypad Programming Select	X				5.17
MSG	Messaging	X		X	X	6.8
MON	Monitor Mode Select	X				5.3
SEL SQ	Normal/Selective Select	X				5.5
OTAR	OTAR Rekey Request	X				11.6.3
DATA	P25 Packet Data Mode	X				5.16.10
PHONE	Phone Call Select	X	X	X	X	5.16.6, 6.6
PRI ED	Priority Channel Select	X				5.11.4
CALL	Private Call Select			X	X	6.5
RWS	Radio Wide Scan Select	X	X	X	X	4.11.3
	Remote Access (Pyramid Repr)					-
RTA	Repeater Talk-Around Select	X				5.8
RWS ED	RWS List Select	X	X	X	X	4.12.2
SCAN	Scan Select	X	X	X	X	4.11.2
SCN ED	Scan Edit Select	X	X	X	X	4.12
SN LST	Scan List Select		X	X	X	4.12
PW CHG	Set User Password	X	X	X	X	3.2
SQ LIST	Squelch Select List	X				5.5
LOCK	Site Lock Select		X		X	6.14.5, 6.14.3
SEARCH	Site Search Select		X		X	6.14.4, 6.14.3
STATUS	Status Select	X	X	X	X	6.9
SURVLC	Surveillance Mode Select	X	X	X	X	4.9
TN VOL	Tone Volume Select	X	X	X	X	4.5
CALL	Unit Call Select	X	X			5.16.5
(Blank)	Unprogrammed (not used)	X	X	X	X	-

## 4.1 OPTION SWITCHES

*NOTE: For descriptions of the functions controlled by these switches, refer to the section of this manual referenced in the last column of Table 4-1.*

The six option switches on the front panel (one is located to the left of the display) can be programmed by the PCConfigure programmer to control a different set of functions for each of the three operating modes. Therefore, up to 18 different functions can be controlled by these switches (six each for conventional, SMARTNET/SmartZone, and P25 Trunking). The available functions in each mode and the section in which each is described are shown in Table 4-1.

## 4.2 TIME-OUT TIMER

The time-out timer disables the transmitter if it is keyed for longer than the programmed time. It can be programmed on each channel for times of 15 seconds to 3 minutes, 45 seconds or it can be disabled.

If the transmitter is keyed continuously for longer than the programmed time, the transmitter is disabled, a continuous tone sounds, and “TX TIMEOUT” is displayed. Five seconds before time-out occurs, a warning beep sounds to indicate that time-out is approaching. The timer and tone are reset by releasing the PTT switch.

A different time can be programmed for each system, and the timer can be enabled or disabled on each conventional channel. With conventional channels, a penalty time can also be programmed that prevents further transmissions for a certain time after the transmitter is disabled (see Section 5.6).

One use of this feature is to prevent a channel from being kept busy for an extended period by an accidentally keyed transmitter. It can also prevent possible transmitter damage caused by transmitting for an excessively long period.

## 4.3 HOME ZONE-CHANNEL SELECT

If the HOME zone option switch is programmed, pressing it selects the preprogrammed home zone and channel. This provides a quick way of returning to a frequently used zone and channel. Pressing and

holding this switch until a tone sounds makes the currently selected zone the new Home zone. The radio is also programmed so that either the home or last selected zone/channel is automatically selected when power is turned on (see Section 3.1).

## 4.4 POWER OUTPUT SELECT

Each conventional channel and SMARTNET/SmartZone and P25 Trunked system can be programmed for High, Low, or Switchable transmit power. If Switchable power is programmed on the channel or system, the Tx PWR option switch can then be used to select high or low transmitter power. All models support switchable power.

Pressing the TX PWR switch toggles the power setting. The new level is flashed in the display when this switch is pressed as “HI POWER” or “LOW POWER”. If selectable power is not permitted on the current channel or system, the fixed power level is flashed and no power change occurs. The selected power level is permanent until it is manually changed again. The power levels are set at the factory or when the radio is tuned using the PCTune™ software. The factory default low power setting is one-half the high power setting.

## 4.5 ALERT TONE SELECT

The various alert tones that sound are described in Section 7.1 on page 51. These tones can be enabled and disabled if the TONE option switch is programmed. To turn all tones off, press this switch and “TONE OFF” is displayed. Then to turn all tones on again, press it and “TONE ON” is displayed. If this switch is not programmed, tones are fixed in the on or off condition by programming. Alert tones are totally disabled when the Surveillance mode is programmed (see Section 4.9).

The Alert Tone volume\* can be adjusted relative to the volume control setting. This is done by programming and also by the user if the TN VOL option switch is programmed. Relative levels of -170 to +170 can be set with “0” the default setting. A minus value decreases the tone volume and a plus value increases it. The user adjusted level permanently overrides the programmed level if applicable.

\* This feature requires firmware Version 1.22/2.0/3.0/4.0 or later.

## 4.6 POWER TURN-OFF DELAY

The radio can be installed so that the vehicle ignition switch as well as the front panel power switch of the radio control power. This is done by connecting the accessory cable ignition switch input to the vehicle ignition switch. Refer to the Installation section of the 5300 Service Manual for more information. A power-off delay of up to 254 minutes can then be programmed or this feature can be disabled by programming “Forever” so there is no automatic power off.

Both the ignition switch and the power switch must then be on for radio power to turn on. The delay can be overridden at any time by turning power off using the front panel power switch or turning the ignition switch back on.

This turn-off delay can allow calls to be received or the horn alert to be active for a time after the ignition switch is turned off. At the same time, advantages of ignition switch control are utilized such as preventing the battery discharge that may occur if the radio is left on for an extended period (see Section 7.6).

## 4.7 HORN ALERT

The horn alert feature\* sounds an external alert such as the vehicle horn when certain calls are received. It is available if a Horn option switch is programmed and the proper connection has been made to the external alert. The horn alert output is pin 4 of the accessory cable, and an external driver circuit of some type is usually required. Refer to the Installation section of the 5300 Service Manual for more information on how to install this feature.

Additional information on the horn alert feature follows:

- It activates when receiving any Unit call in the P25 conventional mode and any Private/Unit and Call Alert (paging) call in the SMARTNET/SmartZone and P25 Trunked modes. It does not sound when receiving standard Group or telephone calls, and is not programmable on a per call basis.
- It must be manually enabled and disabled by the Horn option switch. It is not controlled by the

\* This feature requires firmware Version 1.19/2.0/3.0/4.0 or later.

vehicle ignition switch. When it is enabled, “HORN ON” is briefly displayed, and when it is disabled, “HORN OFF” is briefly displayed. It defaults to the off mode whenever power is turned on.

- If a power turn-off delay is programmed as just described, it is functional during that delay.
- When activated, it can be programmed to sound for three 1-second beeps or continuously for 2-90 seconds. It then turns off until another Unit call is received.

## 4.8 MICROPHONE OFF-HOOK DETECT

The microphone hanger can be connected to chassis ground and the radio programmed to detect an off-hook condition (Hangup Box Monitor selected). The following operation then occurs when the microphone is taken off-hook:

Conventional Channel Selected - Scanning temporarily halts (if applicable) and the Monitor Mode described in Section 5.3 is enabled. However, the receiver unscelches only if a carrier is detected.

SMARTNET/SmartZone/P25 Trunked Channel Selected - Scanning temporarily halts if applicable.

If the off-hook condition is not detected (Hangup Box Monitor not selected), the microphone hook state has no affect on radio operation.

## 4.9 SURVEILLANCE MODE

If the Surveillance mode\*\* is programmed, the backlight, all alert tones, and front panel LED indicator are totally disabled in all operating modes.

This feature can be turned on and off by the user if the SURVLC option switch is programmed. The user selected mode permanently overrides the programmed mode if applicable. This switch is available only with firmware 1.22/2.0/3.0/4.0 or later and PCConfigure 1.20 or later.

## 4.10 PUBLIC ADDRESS

An external public address system can be connected to pin 7 of the radio accessory pigtail cable. This is a low level output, so some sort of PA amplifier

\*\* This feature requires firmware Version 1.16/2.0/3.0/4.0 or later.

is required. The External PA option switch is required to control this feature.

In the public address mode, microphone audio is always routed to the PA system, and the radio can be programmed so that receive audio is also routed. When the PA is enabled/disabled, “Ext PA On/Off” is displayed momentarily. The radio can also be programmed to display “Ext PA On” continuously.

## 4.11 SCANNING

### 4.11.1 INTRODUCTION

Scanning monitors the channels in the scan list for messages the radio is programmed to receive. When a message is detected, scanning stops and the message is received. Shortly after the message is complete, scanning resumes (unless it has been disabled).

If the microphone off-hook condition is detected (Hangup Box Monitor selected by programming), scanning stops and selective squelch (such as Call Guard CTCSS or NAC/group ID detect) is disabled on conventional channels. If the off-hook condition is not detected, taking the microphone off-hook has no effect on radio operation. When a call is received in the scan mode, the alias of the channel on which a call is received (and any other display parameters that may be programmed) are displayed until scanning resumes. The selected channel alias is then displayed if applicable.

There are two scan modes available: Priority (standard) and Radio Wide. The operation of the priority type is unique to the type of channel selected, and the operation of the Radio Wide type is the same regardless of the channel type selected. Only one type of scanning can be enabled at a time. For example, if priority scanning is enabled and Radio Wide Scan is enabled, priority scanning is automatically disabled and vice versa. Refer to the following for more information.

### 4.11.2 PRIORITY (STANDARD) SCANNING

Priority scanning (also referred to as standard scanning) monitors only channels that are the same type as that currently selected. For example, if a

conventional channel is selected, only conventional channels are scanned and likewise for SMARTNET/SmartZone and Project 25 trunked channels.

For more information on scanning functions in the Conventional mode, refer to Section 5.11, and for more information on how it functions in the other modes, refer to Section 6.12. Scanning is turned on and off by the Scan option switch as follows. If this switch is not programmed, scanning is not available.

- To turn priority scanning on, press the SCAN option switch. Scanning is enabled when a rotating  is indicated in the right status display as follows and “SCAN ON” is briefly displayed.

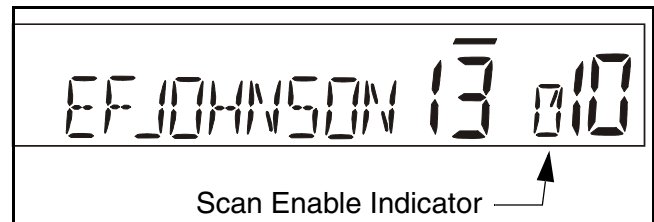

- To turn scanning off, press the SCAN option switch again. On conventional channels with early versions of firmware, this may also select another list, so several presses may be required (see Section 5.11). Scanning is disabled when “SCAN OFF” is briefly displayed and  is no longer indicated in the status display.
- If the zone or channel is changed while scanning is selected, scanning continues on the same or a different scan list (see Section 4.12.1).



*NOTE: Each SMARTNET/SmartZone and P25 trunked channel can be programmed so that scanning is automatically enabled when the channel is selected.*

### 4.11.3 RADIO WIDE SCANNING

*NOTE: Use radio wide scanning only if two different types of channels need to be scanned at the same time such as conventional and SMARTNET/SmartZone. Otherwise, use the more efficient priority scanning because there is less chance of missed calls.*

Radio wide scanning monitors the channels in the preprogrammed radio wide scan list. This scan list

may contain up to 16 channels of any type assigned to any zone (see Section 4.12.2). Radio wide scanning is turned on and off by the **RWS** option switch as follows. If this switch is not programmed, radio wide scanning is not available.

- To turn radio wide scanning on, press the **RWS** option switch and “RW SCN ON” is briefly displayed. In addition,  is displayed the same as with priority scanning.
- To turn radio wide scanning off, press the **RWS** option switch again and “RW SCN OFF” is briefly displayed and  is no longer displayed.
- If the zone or channel is changed while radio wide scanning, scanning continues normally.

#### 4.11.4 SCAN HOLD TIME

When a message is received or transmitted while scanning, there is a delay before scanning resumes. The delay after receiving a call prevents another message from being received before a response can be made. The delay after transmitting a call ensures that a response is heard instead of another message occurring on some other channel.

Separate delay times are programmable for radio wide and priority scanning. With radio wide and conventional priority scanning, delays of 0-7.5 seconds are programmable in 0.5-second steps. With SMARTNET/SmartZone and P25 Trunked priority scanning, a scan delay of 2-10 seconds can be programmed in 0.5-second steps. The radio wide time is programmed on the Radio Wide screen and the Priority time is programmed on the applicable Per System screen.

#### 4.11.5 TRANSMITTING IN THE SCAN MODE

##### Priority Scan Mode

When the transmitter is keyed while scanning is enabled, the transmission may occur on various channels as follows.

**Conventional Operation** - Transmissions can be programmed to always occur on the priority,

selected, or receive channel (if applicable). Refer to Section 5.11 for more information.

##### **SMARTNET/SmartZone/P25 Trunked**

**Operation** - If scanning is halted to receive a message, programming determines if transmissions occur on the selected or active channel. Transmissions at other times occur on the selected channel.

##### Radio Wide Scan Mode

The radio can be programmed to transmit on the selected or active channel similar to SMARTNET/SmartZone and P25 trunked operation just described.

#### 4.11.6 NUISANCE CHANNEL DELETE

With priority scanning, channels can be temporarily deleted from the scan list, for example, if messages become annoying. This feature is not available with radio wide scanning. Channels can also be permanently added or deleted from a scan list as described in the next sections. Proceed as follows to temporarily delete a channel:

*NOTE: The selected channel and also conventional priority channels cannot be deleted from the scan list.*

1. While receiving a message on the channel to be deleted, press and hold the **SCAN** option switch until a tone sounds (approximately 2 seconds). The channel is then deleted and scanning of the remaining channels in the scan list resumes. *NOTE: Pressing and holding this switch on a conventional channel with scanning off may select the scan list. Refer to Section 5.11.2 for more information.*
2. Deleted channels are added back into the scan list if any of the following events occur:
  - Scanning is turned off and then on again using the **SCAN** option switch.
  - Radio power is turned off and then on again.
  - The scan list is reselected by changing channels (SMARTNET/SmartZone) or using the **SCAN** option switch (conventional).

## 4.12 SCAN LISTS

### 4.12.1 PRIORITY MODE SCAN LISTS

#### General

*NOTE: The selected channel is always scanned.*

A scan list is simply the channels that are scanned when scanning is enabled. With all operating modes, as many priority scan lists as are required can usually be programmed (up to 255). The only limitation is the available memory. Each list can include up to 256 channels/talk groups. More information follows on selecting and editing priority scan lists.

#### Determining Channels in Priority Scan List

Channels in the conventional priority scan lists are determined as follows. Channels in the SMARTNET/SmartZone/P25 Trunked priority scan lists are indicated only when editing a list (see “Editing a Priority Scan List”).

1. Enable Priority scanning as described in Section 4.11.2. Also select the scan list if applicable as described in the following “Selecting a Priority Scan List” description.
2. Select the desired zone and then scroll through the channels by rotating the Select switch. When the displayed channel is in the scan list (scanned normally), the  symbol is displayed next to the zone number as shown in the following illustration.

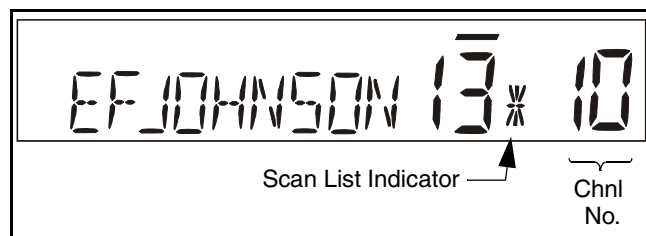

#### Selecting a Priority Scan List

*NOTE: Only Priority scan lists are selectable.*



**Conventional Operation** - The scan list is user selectable by the **SCAN** option switch. Refer to Section 5.11.2 for more information.

#### **SMARTNET/SmartZone/P25 Trunked**

**Operation** - The scan list can be temporarily changed if the Scan (List) Select option switch is programmed. Refer to Section 6.12.3 for more information.

#### Editing a Priority Scan List

If the **SCN ED** (Scan Edit) option switch is programmed, priority scan lists can be user edited as follows (all operating modes). Changes are permanent (cycling power does not reselect a default condition). Proceed as follows:

1. Make sure that both priority and radio wide scanning are off (the rotating  icon is not indicated in the right status display). Select a conventional, SMARTNET/SmartZone/P25 Trunked channel corresponding to the scan list being edited.
2. Select the scan list edit mode by pressing the **SCN ED** option switch. This mode is indicated by a triangle in the upper left corner of the display (see Figure 2-3 on page 11.).
3. If applicable, select the list to be edited by rotating and then pressing the Select switch. The selected scan list is indicated as “LIST x” as described in the preceding section. If user programming is disabled on a list (conventional channels only), “NO EDIT” is momentarily displayed and it cannot be edited.
4. Select the channel you want to add or delete by rotating the Select switch. After the last channel in the current zone is displayed, the first valid channel in the next zone is displayed and vice versa. Lists are limited to 256 channels. If an attempt is made to add more than 256, “LIST FULL” is displayed and a channel must be deleted before another can be added.
5. If the selected channel is in the scan list (scanned), the  symbol is displayed next to the zone number as just described. To change the scan list status of the displayed channel, press the Select switch.

*NOTE: Priority channels can be deleted.*

With conventional channels only, if the selected scan list is programmed with fixed priority

channel(s), the next press of the Select switch makes the current channel the priority channel indicated by “P” in the left status display next to the zone number. If dual priority channels are used, pressing the Select switch again makes it the second priority channel indicated by “2” in the left status display. Then pressing the Select switch again takes the channel out of the scan list. Refer to Sections 5.11.3 and 5.11.4 for more information on priority channel sampling.

- To exit this mode and save the changes, press the SCN ED option switch again.

#### 4.12.2 RADIO WIDE SCAN LIST

##### General

With radio wide scanning, there is only one scan list available regardless of the type of channel selected. This list is user programmable in later models\*, and it can include up to 16 channels of any type. For example, it could include six conventional channels and ten SMARTNET/SmartZone channels. More information on selecting and editing radio wide scan lists follows.

##### Determining Channels in Radio Wide Scan List

The channels in early model radio wide scan lists are indicated by selecting the radio wide scan mode. With later models\*, they can be determined only by selecting the scan list edit mode (see “Editing Radio Wide Scan List” which follows).

When the displayed channel is in the scan list (scanned normally), the  $\mathbb{W}$  symbol is displayed next to the zone number as shown in the following illustration.



##### Editing a Radio Wide Scan List\*

If the RWS ED option switch is programmed, the radio wide scan list can be edited. Changes are permanent (cycling power does not reselect a default condition). Proceed as follows:

- Make sure that both priority and radio wide scanning are off (the rotating  $\mathbb{W}$  icon is not indicated in the right status display). Select the scan edit mode by pressing the RWS ED option switch. This mode is indicated by a triangle in the upper left corner of the display (see Figure 2-3 on page 11.).
- Select the channel you want to add or delete by rotating the Select switch. After the last channel in the current zone is displayed, the first valid channel in the next zone is displayed and vice versa. Lists are limited to 16 channels. If an attempt is made to add more than 16, “LIST FULL” is displayed and a channel must be deleted before another can be added.
- If the selected channel is in the scan list (scanned), the  $\mathbb{W}$  symbol is displayed next to the zone number as just described. To change the scan list status of the displayed channel, press the Select switch.
- To exit this mode and save the changes, press the RWS ED option switch again.

\* This feature requires firmware Version 1.24.1/2.2.1/3.2.1/4.2 or later.



## SECTION 5 CONVENTIONAL FEATURES

### 5.1 INTRODUCTION

An overview of the conventional operating mode is located in Section 3.7.2. The following information describes the features unique to analog and Project 25 (digital) conventional operation. Refer to the preceding “Radio Wide Features” section (Section 4) for information on features common to all operating modes.

### 5.2 MONITORING BEFORE TRANSMITTING

With conventional operation, you may need to manually monitor the channel before transmitting to make sure that it is not being used by someone else. If you were to transmit while someone else was using the channel, you would probably disrupt their conversation. With SMARTNET/SmartZone and P25 Trunked operation, monitoring is performed automatically. Monitor conventional channels automatically or manually as follows:

#### Automatic Channel Monitoring

If the selected channel is programmed for Busy Channel Lockout (also called Transmit Disable On Busy), monitoring is performed automatically. Refer to Section 5.4 for more information on this feature.

#### Manual Channel Monitoring

The automatic monitoring just described may occasionally disable the transmitter when the channel is not in use, such as if the repeater has extended hang time. In this case, you may not want to use it and the channel must then be monitored manually as follows:

**Busy Indicator** - With scanning disabled, note if the multi-function indicator on the front panel is steady green. If it is not, the channel is not being used and a call can be transmitted. If it is green, a carrier is being detected, so the channel may be busy (see following).

**Monitor Mode** - There may be times when the busy indication is displayed even though no one is using the channel. Monitoring should then be performed by

disabling Call Guard squelch (or group ID detect on P25 channels). This is usually done by selecting the Monitor Mode (see following) or by the Normal/Selective option switch (see Section 5.5.2).

### 5.3 MONITOR MODE

The monitor mode unsquelches the receiver and monitors the channel even if a carrier is not detected. Other features of this mode are as follows:

- Call Guard (CTCSS/DCS) squelch is disabled on analog channels and NAC and group ID detect are disabled on P25 (conventional) channels.
- Busy Channel Lockout is overridden (see next section)
- Scanning temporarily halts

The Monitor Mode operates as follows:

1. To monitor the transmit frequency for activity before transmitting, briefly press the **MON** option switch. The display then indicates “MON” (see Figure 2-3 on page 11) and the receiver unsquelches.
  2. To monitor the receive frequency instead, press and hold the **MON** option switch until a tone sounds (approximately 2 seconds). This can be used, for example, to improve reception if intermittent squelching is making a weak message difficult to understand.
- NOTE: If microphone off-hook detection is enabled, the opposite of the above occurs.*
3. To disable the monitor mode and return to normal operation, press the **MON** option switch again.

If off-hook detection is enabled, taking the microphone off-hook monitors the receive frequency similar to step 2. However, the receiver unsquelches only if a carrier is detected (see Section 4.8). Pressing the **SEL SQ** option switch disables Call Guard squelch/P25 group ID detect but not scanning and P25 NAC detect (see Section 5.5).

## 5.4 BUSY CHANNEL LOCKOUT

The Busy Channel Lockout (also called Transmit Disable on Busy) feature automatically disables the transmitter if the channel is busy when the PTT switch is pressed. When the transmitter is disabled by this feature, “BUSY” is displayed, a busy tone sounds, and the transmitter is disabled.

The Busy Channel Lockout feature can be programmed to operate as follows. Each conventional channel can be programmed differently.

**Off** - Busy channel lockout is disabled and the transmitter keys even if the channel is busy.

**Noise** - If a carrier is detected on the channel, the transmitter is disabled when the PTT switch is pressed.

**Tone (NAC)** - If an incorrect Call Guard (CTCSS/DCS) or P25 NAC code (see Section 5.16.3) is detected, the transmitter is disabled when the PTT switch is pressed. An incorrect code is any code other than the one programmed for the current channel.

If Busy Channel Override is permitted by programming, it is possible to transmit even when the transmitter is disabled by this feature. Simply release the PTT switch and then quickly press it again.

## 5.5 CALL GUARD SQUELCH

### 5.5.1 INTRODUCTION

Tone or digital Call Guard squelch (also called CTCSS/DCS signaling) can be programmed on each conventional analog transmit and receive channel in any order desired. The reverse burst and turn-off code are always transmitted and also detected on channels programmed with Call Guard squelch.

The Call Guard squelch feature eliminates distracting messages intended for others using the channel. This is done by using a subaudible tone or digital code to control the squelch. This tone or code is unique to a user or a group on that channel. This tone or code is transmitted with the voice signal but is not heard because it is in the subaudible range and is attenuated by a filter. Call Guard squelch must be used in both the transmitting and receiving radio to be functional.

### 5.5.2 CALL GUARD SQUELCH ENABLE/DISABLE

The **SEL SQ** option switch (if programmed) can be used to disable receive Call Guard squelch on analog channels or group ID code detection on P25 channels. When selective squelch is disabled, “SQ Normal” is flashed in the display, and when it is enabled, “SQ Select” is flashed.

When “SQ Normal” is selected, the receiver unsquelches only if a carrier is detected. Scanning and P25 NAC detection are not disabled with this mode selected. The selected mode remains in effect until it is manually changed. Selecting another channel or cycling power does not reselect a default condition. There is a programmable option to display “MON” when the “SQ Normal” mode is selected (firmware Version 1.28/2.6/3.6/4.2 or later).

### 5.5.3 TONE CALL GUARD SQUELCH

Tone-type Call Guard squelch utilizes subaudible CTCSS tones from 67-254.1 Hz. Although there are 42 tones assigned, those above 33 (210.7 Hz) are normally not used because of their close proximity to the voice band which starts at 300 Hz. In addition, tones 11 (97.4 Hz), 39 (69.3 Hz), 40 (206.5 Hz), 41 (229.1 Hz), and 42 (254.1 Hz) are normally not used because they may cause interference with adjacent tones.

A reverse burst is transmitted when the push-to-talk switch is released and also detected when calls are received. It is a 180-degree phase reversal for a period of time determined by the tone frequency, and it eliminates the squelch tail (noise burst) in the receiving radio. Both the transmitting and receiving radio must be equipped with this feature for it to be utilized.

### 5.5.4 DIGITAL CALL GUARD SQUELCH

Digital Call Guard squelch (DCS) uses digital data instead of subaudible tones to control the squelch. This data consists of continuous repetitions of 23-bit words. No bit or word synchronization information is used. When the push-to-talk switch is released, a turn-off code is transmitted which eliminates the squelch tail similar to the reverse burst.

Although there are thousands of possible code combinations with 23 bits, only 83 are unique with the

data scheme used. The number specified when the code is programmed is actually a seed for a special algorithm used to generate the 23-bit data word. The data is transmitted at a rate of 134.4 bits per second. Therefore, approximately six words are transmitted each second. When the data is decoded, 23-bit samples are taken and then the bits are rotated to determine if a valid code was received.

### 5.5.5 SELECTIVE SQUELCH CODE SELECT (CTCSS/DSC/NAC)

*NOTE: Call Guard codes may be permanently reprogrammed by keypad programming (see Section 5.17).*

This feature allows the normal transmit and receive Call Guard (CTCSS/DCS/NAC) programming to be temporarily overridden with a code selected from a preprogrammed list. It is available if the **SQ LIST** option switch and a CTCSS/NAC code list have been programmed.

In addition, with the Handheld Control Unit (HHC) only, conventional systems can be programmed for the Keypad CTCSS/DSC feature. Codes can then be selected directly from the table by pressing the key for the code. For example, to select code 3 from the table, simply press the “3” key. No other conventional mode functions can then be assigned to these keys.

The CTCSS/DCS/NAC list is programmed with up to 64 tone (CTCSS) or digital (DCS) Call Guard codes. Different codes can be programmed for the transmit and receive modes, and carrier squelch (selective squelch disabled) can be programmed if desired. In addition, each position can be programmed with an NAC code for use with P25 operation.

When the Call Guard code is changed using this feature, it remains selected even if other channels are selected. However, if radio power is cycled or a talk-around channel is selected, the normal codes are reselected. When scanning, the selected code also applies to all scanned channels. Each channel can also be programmed to always ignore the code selected from this list and use the default code instead (firmware Version 1.28/2.6/3.6/4.2 or later).

If both analog and digital (Project 25) channels can be selected or scanned, the CTCSS/DCS code for

the selected position is used for analog channels and the NAC code for the selected position is used for P25 channels. If a channel is programmed for mixed mode operation, the selective squelch type (analog or digital) programmed for the transmit mode determines the selective squelch type used.

Proceed as follows to select a code using the **SQ LIST** option switch:

1. Press the **SQ LIST** option switch and then rotate the Select switch to select the desired position. The display indicates “SEL SQ xx” where, “xx” is the selected code from 1-64. The code number and actual code are alternately displayed with firmware Version 1.28/2.6/3.6/4.2 or later (NACs are displayed in hexadecimal)
2. To select the displayed code and return to the normal display, press the Squelch Code Select switch again.
3. To check which code is selected, press the **SQ LIST** option switch once to display the current selection and then again to return to normal operation.
4. To return to the normal selective squelch codes, select “DEFAULT” in this mode. As previously described, the normal codes are also automatically reselected whenever radio power is cycled or a talk-around channel is selected.

### 5.6 PENALTY TIMER

A penalty timer may be programmed on conventional systems to prevent transmissions for the programmed time after the time-out timer disables the transmitter (see Section 4.2). The penalty timer can be programmed for the same times as the time-out timer, and timing starts when the PTT switch is released. If the PTT switch is pressed during the penalty time, the time-out indication occurs again and the transmitter remains disabled. When the penalty timer expires, a beep sounds and the transmitter can then be keyed.

### 5.7 CONVERSATION TIMER

A conversation timer can be programmed on conventional systems in addition to the time-out timer (see Section 4.2). This timer limits that total length of a conversation rather than just the length of each trans-

mission as with the time-out timer. The following is more information on this timer.

- It can be programmed for times up to 7.5 minutes.
- It is reset when the time between transmissions exceeds the time programmed for the penalty timer.
- A warning beep sounds 5 seconds before this timer disables the transmitter.
- When this timer disables the transmitter, a continuous tone sounds and the red transmit indicator turns off. The PTT switch must then be released until the penalty timer expires (indicated by a beep).

## 5.8 REPEATER TALK-AROUND

Normally, all transmissions go through a repeater which usually increases range. However, there may be times when a mobile is out of range of the repeater and therefore unable to talk to anyone even though the mobile being called is only a short distance away. To allow communication in this situation, repeater talk-around can be selected. Transmissions then occur on the receive frequency which permits direct mobile-to-mobile communication.

Repeater talk-around can be selected if the RTA option switch is programmed. When talk-around is enabled by this switch, “RTA ON” is flashed in the display, and when it is disabled, “RTA OFF” is flashed. This feature remains enabled during scanning, and changing channels or turning power off does not change the selected condition. Talk-around is available on conventional channels only.

## 5.9 DISPLAYING TRANSMIT/RECEIVE FREQUENCY

If the DISP option switch is programmed, it can be used to display the channel frequency in megahertz. Pressing this switch toggles between displaying the standard channel alias and the frequency. The receive frequency is displayed while receiving and the transmit frequency is displayed while transmitting. This feature is available on conventional channels only.

## 5.10 EMERGENCY ALARM AND CALL

*NOTE: The following enhanced conventional emergency features require firmware 1.21/2.0/3.0 or later and PCConfigure 1.19 or later.*

### 5.10.1 INTRODUCTION

Emergency Alarms and Calls are separate functions that can be individually enabled or disabled on each analog and P25 conventional system. The Emergency option switch is required for these functions. Emergency Alarms and Calls are transmitted on the global (radio wide) emergency zone/channel if one is programmed. If it is not programmed, the emergency is transmitted on the selected channel. The emergency programming of the system to which that channel is linked controls the emergency operation.

### 5.10.2 EMERGENCY ALARMS

An emergency alarm is a special transmission that alerts a dispatcher of an emergency situation. It is sent automatically by simply pressing Emergency option switch. The system to which the emergency channel is linked must have Emergency Alarms enabled. If it does not, Emergency Alarms are disabled.

In the P25 conventional mode, a special P25 emergency data transmission is sent, and in the conventional analog mode, an DTMF emergency ID is sent. This ID is programmed on the Conventional Radio Wide screen. Refer to Section 5.15 for information on the MDC1200 Emergency Alert.

Proceed as follows to send an emergency alarm:

1. If required, select a channel of a system on which Emergency Alarms are enabled and then press the EMER option switch. The radio then automatically transmits the emergency alarm.
2. Either Normal or Silent operation can be programmed. With the Normal mode, the red LED lights, the emergency tone sounds, and “EMERGENCY” flashes in the display. This indication continues to flash until the alarm mode is ended (see step 4).

If silent programmed or the Surveillance mode is selected (see Section 4.9), none of these indications occur. If “No Receive Activity During Emergency” is programmed, receive audio, the front panel LED, and receive icons are disabled in the receive mode (firmware Version 1.28/2.6/3.6/4.2 or later only).

\* This feature requires firmware 1.24.1/2.2.1/3.2.1 or later and PCConfigure 1.22.0 or later.

3. When the emergency alarm is acknowledged by the dispatcher, "ACK RCVD" is briefly displayed and the emergency acknowledge tone (two beeps) sounds. This alert tone can be disabled if desired, and neither occur if Silent operation is programmed.
4. The emergency alarm mode is exited when radio power is cycled or by pressing and holding\* the Emergency option switch.

### 5.10.3 EMERGENCY CALLS

#### General

The Emergency Call feature allows a user to place an emergency voice call by pressing the PTT switch after pressing the Emergency option button. If the Emergency Hot Mic feature is enabled, the emergency call is automatically transmitted without having to press the PTT switch (see following description). The system to which the emergency channel is linked must have Emergency Calls enabled. Analog and Digital (P25) calls can be individually enabled.

If the emergency call is sent on a P25 channel, an emergency indication is sent according to the P25 standard (the emergency bit is set in the Common Air Interface). If it is sent on an analog channel, the DTMF Emergency ID is sent in place of the ANI DTMF PTT ID if applicable. *NOTE: The DTMF Emergency ID is sent only if pre- or post- DTMF ANI is enabled on the channel by programming.*

#### Emergency Hot Mic

If Emergency Hot Mic has been enabled for emergency calls, automatic transmitting occurs with microphone audio unmuted without having to manually press the PTT switch. The automatic transmit period is programmed for 10-120 seconds in 10-second intervals. If this feature or emergency calls are not enabled by programming, automatic transmitting does not occur. This feature is initiated only on the first press of the Emergency switch. Subsequent presses do not trigger automatic transmissions. To reset this function, the channel must be changed or power cycled.

#### Placing an Emergency Call

1. If required, select a channel of a system on which Emergency Calls are enabled and press the EMER option switch. The Emergency Alarm is then sent as described in Section 5.10.2 if applicable.
2. If the preceding Emergency Hot Mic feature is enabled, the call is automatically transmitted without pressing the PTT switch. If it is disabled, press the PTT switch and begin speaking as with a standard call. If the channel is changed, operation continues on the new channel in the emergency mode.
3. With analog calls, subsequent presses of the PTT switch cause the DTMF emergency ID to be sent according to the ANI programming (if DTMF ANI is enabled on the channel). With digital calls, the calls continue to have the emergency bit set.
4. If the Surveillance Mode is enabled (see Section 4.9), all indicators, lights, and tones are disabled. If "No Receive Activity During Emergency" is programmed, receive audio, the front panel LED, and receive icons are disabled in the receive mode (firmware Version 1.28/2.6/3.6/4.2 or later only).
5. To exit this mode, cycle radio power or press and hold\* the Emergency switch.

### 5.11 CONVENTIONAL MODE SCANNING

#### 5.11.1 GENERAL

Channel scanning features common to all operating modes are described in Sections 4.11 and 4.12. The following information describes features unique to conventional operation.

#### 5.11.2 SELECTING A SCAN LIST

##### Default Scan List

Conventional systems are programmed with a default scan list that is normally selected by all channels in that system. However, there is a programmable option to slave a particular conventional scan list to a zone (firmware 1.28/2.6/3.6/4.2 or later only). This

\* This feature requires firmware Version 1.24.1/2.2.1/3.2.1/4.2 or later.

then becomes the default list for all conventional channels in that zone (it overrides the system programming). This slave feature is programmed on the Edit Zone screen.

If the **SCAN** option switch is programmed, the default list selected by all conventional channels (even those belonging to slaved zones) is temporarily changed. The preceding default scan lists are automatically reselected whenever radio power is cycled.

#### Conventional Scan List Select Procedure

The scan list select procedure is revised with later 53xx models. The procedures for revised and early models are as follows:

##### **Revised 53xx Models (Firmware 1.28/2.6/3.6/4.2 or Later)**

1. With scanning off, press and hold the **SCAN** option switch until a tone sounds (scanning is off when the rotating  is not indicated in the right status display). If required, turn scanning off by briefly pressing this switch. If the **SCAN** option switch is pressed while scanning, Nuisance Channel Delete described in Section 4.11.6 is performed.
2. The currently selected list is then indicated in the display as “SCAN LIST x”, where “x” is the scan list number. Rotate the Select switch to select the desired list and then exit this mode by pressing the Select or **SCAN** option switch.

##### **Early 53xx Models (Prior Firmware Versions)**

With firmware versions prior to those listed above, conventional mode scan lists are selected and scanning is turned on and off by repeatedly pressing the **SCAN** option switch. For example, if three scan lists are programmed, the first press activates scanning and scan list 1, the second activates scan list 2, the third activates scan list 3, and the fourth disables scanning and the cycle repeats. The currently selected scan list is indicated as described above.

#### 5.11.3 TRANSMITTING IN SCAN MODE

Each conventional scan list can be programmed for one of the following modes. These modes deter-

mine if priority sampling occurs and also the channel on which transmissions occur while scanning. Refer to the next section for more information on priority sampling.

**No Priority** - No priority channel sampling occurs when the list is selected. The radio transmits on the selected channel.

**Priority/Tx Selected** - Priority sampling occurs and the priority channel or channels are those programmed in the selected scan list. The radio transmits on the selected channel.

**Priority/Tx Priority (1)** - Priority sampling occurs and the priority channel or channels are those programmed in the selected scan list. The radio transmits on the priority (1) channel.

**Priority (1) on Selected** - The priority (1) channel is always the selected channel. The radio transmits on the selected channel.

**Talkback** - No priority sampling occurs. The radio transmits on the channel of a call while scanning is halted. Then once scanning resumes, it transmits on the selected channel.

#### 5.11.4 PRIORITY CHANNEL SAMPLING

*NOTE: The following describes priority sampling when scanning conventional channels. Priority sampling when scanning SMARTNET/SmartZone/P25 Trunked channels is described in Section 6.12.2.*

##### General

The priority channel sampling feature ensures that when priority scanning, messages on the priority channel are not missed while listening to a message on some other channel. The radio can be programmed as just described so that the priority channel is a fixed channel programmed in the current scan list, the currently selected channel, or not used.

*NOTE: Priority channel sampling is not available when receiving analog encrypted (DES/DES-XL) calls, and also when receiving P25 calls if equipped with ARM firmware 1.23 or earlier. In addition, the priority channel is not scanned if the active channel is an*

*analog channel on the same frequency as the priority channel and is programmed with CTCSS/DCS squelch control.*

Either a single or dual priority\* channels can be programmed if desired. With dual priority, a call on the second priority channel is interrupted by a call on the first priority channel but not vice versa. When scanning and the selected channel is a single or first priority channel, “P” is indicated in the left status display next to the zone number as follows:

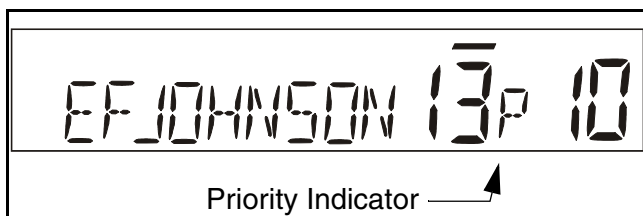

This indication is displayed regardless of whether the priority channel is fixed or always the selected channel. When the second priority channel is displayed, “2” is indicated instead.

The priority channel sampling frequency is determined by the programmed Priority Lookback Time A (see description which follows). For example, if 2.0 seconds is programmed, the priority channel is sampled every 2.0 seconds when listening to a message on a non-priority channel. When not listening to a message, the priority channels are scanned in the normal scan sequence. With dual priority, the first and second priority channels are alternately sampled at the Loopback Time.

Priority channel sampling occurs only with standard conventional scanning. It does not occur with radio-wide scanning, when listening to any type of SMARTNET/SmartZone/P25 conventional or trunked call, encrypted call, or when transmitting. A series of “ticks” may be heard when the priority channel is sampled while listening to a message on some other conventional channel.

The priority sampling times are programmed by the following parameters:

**Lookback Time A** - This time determines how often the priority channel is checked for activity. Times of 0.25-4.00 seconds in 0.25-second steps can be programmed.

*\* This feature requires firmware Version 1.17/2.0/3.0/4.2 or later.*

**Lookback Time B** - This time determines how often the priority channel is checked once an incorrect Call Guard (CTCSS/DCS) or NAC code is detected. Since it takes much longer to detect an incorrect Call Guard signal than a carrier, this time should be relatively long to prevent the interruptions from making a message difficult to understand. Times of 0.5-8.0 seconds can be programmed in 0.5-second steps.

Changing The Priority Channel

If a fixed priority channel is associated with the current scan list, it can be changed to another channel if the PRI ED option switch is programmed. With dual priority, this changes only the first priority channel. To change both priority channels, use the Scan List Edit function described in Section 4.12.1. Proceed as follows to change a priority channel using the PRI ED option switch:

1. Make sure that both priority and radio wide scanning are off (the rotating  icon is not indicated in the right status display).
2. Select the channel that you want to be the priority channel using the Select switch in the normal manner. If the channel is in a different zone, also select the appropriate zone.
3. Press the PRI ED option switch and “Priority” is briefly displayed to indicate that the selected channel is now the priority channel. Other indications that may occur are as follows:
  - If “No Priority” is displayed, priority sampling may not be enabled on the scan list.
  - If “Sel Chan” is displayed, the priority channel is always the selected channel and cannot be changed.
  - If no indication displayed, the scan list may not be user editable or the channel may not be in the scan list.

**5.12 STANDARD CONVENTIONAL CALLS**

Standard conventional calls can be placed to other mobile units monitoring the selected channel. The proper coded Call Guard squelch tone or code or P25

NAC may need to be transmitted by your radio for them to receive your call (see Sections 5.5 and 5.16.3).

#### Placing a Standard Conventional Call

1. Turn power on and set the volume as described in Section 3.1 on page 13. Select the channel programmed for the mobile you want to call (see Section 3.4.2 on page 14).
2. Monitor the channel automatically or manually as described in Section 5.2 on page 25.
3. Press the PTT switch and if the Busy Channel Lockout feature is programmed on the channel, the transmitter is automatically disabled if the channel is busy (see Section 5.4). Otherwise, busy and out-of-range conditions are not indicated and speaking can begin after monitoring the channel.
4. Press (and hold) the PTT switch to talk and release it to listen. When the call is finished, place the microphone back on-hook.

#### Receiving a Standard Conventional Call

1. Select or scan the channel programmed for the call you want to receive (refer to Section 5.11 for more scanning information).
2. When the call is received, take the microphone off-hook and press the PTT switch to talk and release it to listen. If scanning, responses may occur on the priority, selected, or receive channel as described in Section 5.11.3.
3. When the call is finished, place the microphone back on-hook.

### 5.13 DTMF/ANI SIGNALING

DTMF (Dual Tone Multi-Frequency) tones can be generated for ANI (Automatic Number Identification) and other purposes on conventional analog channels. One of the following options may be enabled on each channel:

**Pre-Tx ANI** - A preprogrammed ANI sequence is automatically sent each time the PTT switch is pressed.

**Post-Tx ANI** - A preprogrammed ANI sequence is automatically sent each time the PTT switch is released.

When an emergency alarm or call is placed, this ANI signaling is replaced by the Emergency DTMF ID (see Section 5.10). Refer to Section 5.15 for information on MDC1200 ANI.

### 5.14 SINGLE TONE ENCODER

This feature is not available with the 5300 mobile. It is available with the 5100 portable only.

### 5.15 MDC1200 COMPATIBILITY

MDC1200 is a signaling protocol designed and implemented by Motorola for analog channels only. The following features of this protocol are supported. Either MDC1200 or standard DTMF ANI/Emergency signaling can be programmed on each conventional system. *NOTE: This feature is available only with radio platforms that use Version 4.2 or later firmware (it is also hardware dependent and therefore cannot be added to others by simply upgrading firmware).*

MDC1200 ANI - Both pre and post ANI are supported.

MDC1200 Emergency Alert - A retry counter is implemented. Currently, ACKs are not decoded so the radio retries the programmed number of times with each emergency.

### 5.16 PROJECT 25 MODE FEATURES

*NOTE: The following features are unique to conventional P25 channels.*

#### 5.16.1 UNIT ID CODE

Each radio that operates on Project 25 (digital) channels is programmed with an eight-digit unit ID. This ID is unique for each radio and can be any number from 1-16,777,216. When power is turned on with a Project 25 channel selected, this ID is briefly displayed.

#### 5.16.2 GROUP ID CODE

Each Project 25 channel is programmed with a group ID that determines which group of mobiles will



receive the call. A call is received on a channel if a selected or scanned channel is programmed with that ID and the correct NAC is detected (see following). Group IDs can be any number from 0-65,535. Group ID detect can be disabled by the Normal/Selective squelch function described in Section 5.5 and the Monitor Mode described in Section 5.3.

### 5.16.3 NETWORK ACCESS CODE (NAC)

Project 25 conventional channels also use a NAC (Network Access Code) to control which calls are received on a channel. The NAC can be 0-4095, and each transmit and receive channel can be programmed for a different code. Other operation, such as monitoring before transmitting, is similar to that of analog channels. NAC (and group ID) detect can be disabled by the monitor mode described in Section 5.3.

### 5.16.4 P25 GROUP CALLS

#### General

P25 Group calls are placed by simply selecting the channel programmed for the desired group, monitoring the channel if required, and transmitting. When a P25 group call is received, the alias (or frequency) of the selected channel is displayed. The radio can be programmed so that the following are also displayed for 0.5-7.0 seconds or continuously during the call.

**P25 PTT ID** - The unit ID of the mobile placing the call is displayed.

**P25 Talk Group** - The alias of the talk group on which the call is being received is displayed.

**User Group ID\*** - If the group ID of the call being received is included in a preprogrammed User Group ID list, the alias programmed in that list for that group is displayed.

#### Changing Talk Group Assigned To a Channel

If the TG SEL option switch is programmed, the talk group assigned to a channel can be changed by the user. The new talk group continues to be assigned to the channel until it is manually changed again (cycling power or selecting another channel does not reselect a

default talk group). Change the talk group assigned to a channel as follows:

1. Select the channel to be changed and then press the TG SEL option switch.
2. Rotate the Select switch to display the talk group to be assigned to that channel. Talk groups are indicated by a unique identification in the alphanumeric display.
3. To select that talk group and return to normal operation, press the TG SEL switch again or press the Select switch. If talk group selection has been disabled on the channel by programming, the talk group does not change, "NO LIST" is displayed, and a tone sounds.

### 5.16.5 P25 UNIT CALLS

Unit calls (also called Individual Calls) can be placed to a specific radio on Project 25 channels If the CALL option switch is programmed. Only the individual ID of the target radio is sent (a talk group ID is not sent). The mobiles that can be called are preprogrammed in the Unit Call list.

To receive a unit call, the RF channel of the call must be selected or scanned and the correct NAC and unit ID must be detected. The ID of the calling radio is then transmitted back. To respond to the call, the radio must be programmed with the CALL option switch, and have a Unit Call programmed with the ID of the calling mobile.

Place and receive a Unit Call as follows:

1. To transmit a unit call, press the CALL option switch. The alias (tag) of the last Unit Call is displayed.
2. If required, rotate the Select switch to display the desired call. The alias and ID of the unit calls that have been programmed are alternately displayed.
3. Press and then release the PTT switch. Ringing is then heard and "WAIT" displayed to indicate that the mobile is being rung. To disable this ringing but not the call, briefly press the PTT switch again.

\* This feature requires firmware 1.24.1/2.2.1/3.2.1/4.2 or later.

Ring occurs for 20 seconds or until the call is answered, whichever occurs first.

4. When a unit ID call is received, two beeps sound (if tones are enabled), and “Call Rcvd” and the alias of the Unit ID are alternately flashed.
5. To respond, select the Unit Call mode by pressing the CALL option key. The following operation then occurs:
  - If a unit call has been programmed with the ID of the calling mobile, it is automatically selected. A response can then be made without changing the selected channel.
  - If no Unit Call has been programmed with the ID of the calling mobile, a response cannot be made in this mode.
  - If the call timer times out (set by programming) or the channel is changed before a response is made, the unit call mode is exited.

### 5.16.6 P25 CONVENTIONAL TELEPHONE CALLS

#### General

Telephone calls can be placed and received on P25 conventional channels if equipped with firmware 2.6 and 4.2 or later. This feature is not available with 1.xx (ARM) or 3.x (UCM) software versions. This feature allows telephone calls to be placed and received over the public telephone system using your radio. Telephone calls are programmed to operate in one of the following modes:

- Disabled
- Answer-only capability
- List only - Telephone numbers can be selected from a preprogrammed list only (direct entry as follows is not allowed)
- Unlimited - Telephone numbers can be selected from a list and also dialed directly entered using the front panel controls or the HHC keypad.

All models with the above firmware or later have the capability to place telephone calls by recalling the number from a list or dialing it using the front panel controls or using the Handheld Control Unit (HHC)

telephone keypad. More information on how to do this follows.

#### Access/De-Access Codes

P25 conventional telephone calls utilize an access to access the system when placing a telephone call, and a de-access code to terminate the call when it is finished. These codes are preprogrammed in pairs by the Access/De-Access Code list selected on the conventional Per System screen, and up to 16 pair can be programmed. Each conventional P25 channel can be programmed to automatically select one of these code pairs. They must match the system codes, and the default code is \*1P# (the P represents a pause).

#### Placing a Telephone Call

##### **Recalling From List**

1. Select the conventional channel that is programmed to select the desired access and de-access codes.
2. Momentarily press the PHONE option switch and the display indicates the last number dialed by alternately displaying “Last Num” and the telephone number. In addition, the phone mode is indicated by the  icon.
3. If required, rotate the Select switch to display the desired number. The alias and telephone number are alternately displayed.
4. Briefly press the PTT switch to send the access code. A dial tone sound should then be heard. Briefly press the PTT switch again to send the digits. Proceed to step 5 which follows.

##### **Direct Entry Using Front Panel Controls or HHC Keypad**

1. Select the conventional channel that is programmed to select the desired access and de-access codes.
2. Press and hold the PHONE option switch until a tone sounds (approximately 1 second). The alias of the last called telephone number is displayed if it is in the phone number list. Otherwise, only the last eight digits are displayed. In addition, the phone mode is indicated by the .

3. If using the front panel controls, enter the telephone number by rotating and pressing the Select switch. The 0-9, \*, #, and P (pause) characters can be entered (# is displayed as a "+"). Numbers up to sixteen digits (including pauses) can be entered, and the number scrolls to the left in the display so that the eight right-most digits are always displayed. With the HHC, enter the number using the DTMF keypad (a pause indicated by "P" is entered by \* #).
4. Briefly press the PTT switch to send the access code. A dial tone sound then be heard. Briefly press the PTT switch again to send the digits.
5. Press the PTT switch to talk and release it to listen. Since the radio operates half duplex, it is not possible to talk and listen at the same time.
6. When the telephone call is finished or if it could not be completed for some reason, end it by pressing the PHONE option switch again and placing the microphone back on-hook. This sends the de-access code which tells the system that the call is finished and that the repeater can be released.

#### Answering a Telephone Call

1. When a telephone call is received, "ringing" similar to a standard telephone is heard and "PHONE" is displayed.
2. To answer the call, press the Phone option switch and press the PTT switch to talk and release it to listen.
3. When the call is finished, end it as in the preceding step 6.

### 5.16.7 CALL ALERT

#### General

The Call Alert™ feature\* allows pages to be sent and received on P25 conventional channels. Operation is similar to SMARTNET/SmartZone and P25 Trunked channels.

#### Answering a Page

1. When a page is received, five beeps sound and "PAGE" is displayed. The ID of the mobile paging you is stored as the last ID received.
2. To clear or ignore the page, press any option switch. If the PTT switch is pressed, a group call is placed on the selected channel.
3. To answer the page as a unit call (see Section 5.16.5), press the CALL (Private/Unit) option switch and the alias of the mobile paging you is displayed. Press the PTT switch and respond. One of the following conditions then occur:
  - If the mobile being called is on the air, ringing is heard until the called party answers or for 20 seconds, whichever occurs first. If no answer occurs within 20 seconds, a continuous tone sounds and "NO ANS" is displayed.
  - If the mobile being called is not on the air, a continuous tone is heard instead of ringing and "NO ACK" is displayed.
4. When the call is finished or if it could not be completed for some reason, end it by pressing the Unit Call option switch or the F1 (Exit) key.

#### Initiating a Page

1. With a P25 conventional channel selected, momentarily press the ALERT (Call Alert) option switch. The alias of the last ID called is displayed.
2. If required, rotate the Select switch to display the desired mobile. The alias of each number is displayed.
3. Press the PTT switch and one of the following occur:
  - If five beeps sound, the system received the page and the paged mobile is on the air and received it. The page mode is automatically exited.
  - If the system received the page but the called mobile is not on the air, a single beep sounds and

\* This feature requires 5300 operating (ARM) software 1.22 or later and PCConfigure 1.20 or later.

“NO ACK” is displayed 6 seconds after the PTT switch is pressed. Auto exit then occurs.

### 5.16.8 MESSAGING

The messaging feature\* allows preprogrammed messages to be sent to a dispatcher on P25 channels. Up to 16 messages can be preprogrammed, and they are identified by an alias. If a **MSG** (Message) option switch is programmed, messages are sent as follows:

1. Momentarily press the **MSG** option switch. The alias of the last message sent is displayed.
2. If required, rotate the Select switch to display the desired message. Then send the message by momentarily pressing the PTT or Select switch. One of the following events then occurs:
  - If five beeps sound and “ACK RECVD” is displayed, the message was received and automatically acknowledged by the system.
  - If after five tries the message is not acknowledged, a tone sounds and “NO ACK” is displayed.

### 5.16.9 STATUS MESSAGING

The status messaging feature\* allows you to manually or automatically send your current status to your dispatcher on P25 channels. Up to eight status conditions can be preprogrammed, and they are identified by an alias. If the **STATUS** option switch is programmed, status conditions are sent as follows:

1. Momentarily press the **STATUS** option switch. The alias of the current status condition is displayed.
2. To change the current status, rotate the Select switch until the desired status is displayed. Then to send the status, momentarily press the PTT switch. One of the following events then occurs:
  - If five beeps sound and “ACK RCVD” is displayed, the status was received and acknowledged by the system.
  - If after five tries the message is not acknowledged, a tone sounds and “NO ACK” is displayed.

\* This feature requires firmware Version 1.22/2.0/3.0/4.2 or later.

### 5.16.10 P25 PACKET DATA

P25 packet data transmission capability is available with later model\*\* 5300 mobiles. A **DATA** option switch must be programmed to toggle the data mode on and off.

The P25 Packet Data mode allows a subscriber unit to act as a packet data modem for a remote application connected to the subscriber unit via an RS-232 or SLIP (Serial Line Internet Protocol) connection. The SLIP connection requires an Ethernet port which is currently not available.

A special Data Pigtail Cable, Part No. 597-2002-282, is installed in the radio to provide the RS-232 port (female DB9 connector) for connecting the external data equipment to the 5300 mobile.

## 5.17 KEYPAD PROGRAMMING

*NOTE: The Keypad programming feature is available to Federal Government users only. Users regulated by the Federal Communications Commission (FCC) are not allowed to have this feature. With ARM code 1.22 or later, this feature must be factory enabled to be selected. This was not required with previous code versions.*

### 5.17.1 INTRODUCTION

Since keypad programming is permitted by Federal Government users only, only Federal models of this transceiver can be programmed with this feature. It is then available only if it has been enabled by factory programming and a conventional mode option switch is programmed for the “Keypad Programming” function.

Keypad programming is then selected by simply pressing the **PROG** option switch (password entry is not required). The keypad programming mode is indicated by “CHNG ZONE” and a triangle in the display as follows:



\*\* This feature requires firmware 1.24.1/2.2.1/3.2.1/4.2 or later.

Keypad programming allows conventional channel parameters such as the transmit and receive frequency, Call Guard squelch code, and encryption key to be changed. In addition, several conventional mode timers can be changed. It cannot be used to reprogram disabled channels or any P25 Trunked, SMARTNET, or SmartZone information.

### 5.17.2 MENU STRUCTURE

A menu system is used to select parameters in the keypad programming mode. Rotate and press the Select switch to scroll through and select the available parameters. The available parameters and the section in which each is described are as follows:

- **CHNG ZONE (5.17.4)**
- **CHNG CHAN (5.17.5)**
- **SYS PARMS (5.17.6)**
- **CHAN PARMS (5.17.7)**

Press the Select switch to select the displayed parameter. Press the PROG option switch from one of the main menus to exit keypad programming or from other menus to exit back one level. A flowchart showing the keypad programming mode menu structure is located Figure 5-1. Refer to the descriptions which follow for more information.

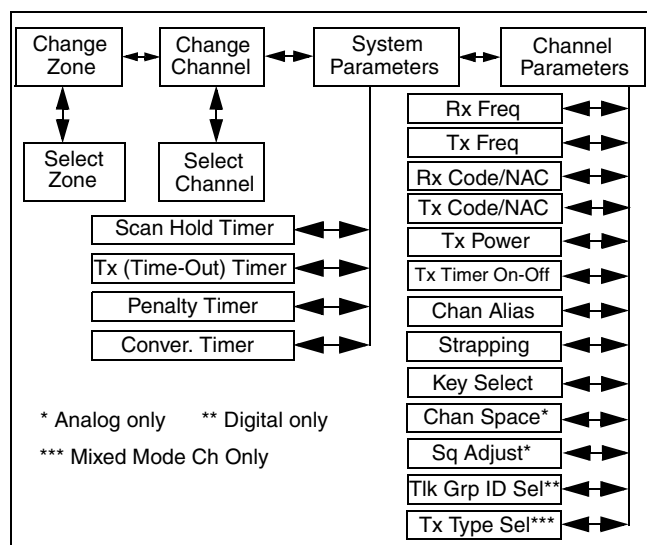

**Figure 5-1 5300 Keypad Programming Menu Flowchart**

### 5.17.3 ZONE PASSWORD

**NOTE:** Make sure that the zone password(s) are not lost because they cannot be overridden in the field. The PCConfigure software must be used to display the lost password or program a new password.

Each zone can be programmed with a password by the PCConfigure software to prevent unauthorized reprogramming of zone by keypad programming. When this password is programmed, it must be entered before system or channel parameters in that zone can be changed by keypad programming. The zone password is programmed in the Zones > Edit Zone screen of the PCConfigure programmer. This screen is displayed by clicking the Edit Zone button. A different password can be programmed for each zone.

When an attempt is made to select a system or channel parameter in a password protected zone, “PASSWORD” is flashed. The password is always eight digits long and is entered using the same procedure as used for the power-up password described in Section 3.2. After the password is entered, system and channel parameters for that zone can be reprogrammed normally.

### 5.17.4 ZONE CHANGE PARAMETER

The “CHNG ZONE” menu parameter selects the zone containing the conventional channel to be reprogrammed. It does not change the zone selected for normal operation.

Press the Select switch to select the “CHNG ZONE” parameter and then scroll through the programmed zones by rotating that switch. When the desired zone is displayed, select it by pressing the Select switch.

### 5.17.5 CHANNEL CHANGE PARAMETER

The “CHNG CHAN” menu parameter selects the conventional channel to be reprogrammed. Disabled or P25 Trunked/SMARTNET/SmartZone channels cannot be selected. This does not change the channel selected for normal operation.

Press the Select switch to display “CHNG CHAN” and then scroll through the programmed

channels by rotating that switch. When the desired channel is displayed, select it by pressing the Select switch.

### 5.17.6 SYSTEM PARAMETERS

*NOTE: If “PASSWORD” is briefly displayed when attempting to select a parameter, see Section 5.17.3.*

The “SYS PARMS” menu parameter selects the conventional mode timer to be reprogrammed (see following). Press the Select switch to select “SYS PARMS” and then rotate that switch to display the desired parameter. Then press the Select switch again to select it.

**SCAN TIMER** - Selects the Scan Hold timer. Rotate the Select switch to decrement/increment the timer in 0.5-second steps from 0-7.5 or set it to 0 seconds to disabled it. When the desired value is displayed, store it by pressing the Select switch.

**TX TIMER** - Selects the transmit time-out timer. Rotate the Select switch to decrement/increment the timer in 15-second steps from 0-225 or disable it by selecting 0 seconds. When the desired value is displayed, store it by pressing the Select switch.

**PEN TIMER** - Selects the penalty timer. Rotate the Select switch to decrement/increment the timer in 15-second steps from 0-225 or disable it by selecting 0 seconds. When the desired value is displayed, store it by pressing the Select switch.

**CONV TIMER** - Selects the conversation timer. Rotate the Select switch to decrement/increment the timer in 30-second steps from 0-450 or disable it by selecting 0 seconds. When the desired value is displayed, store it by pressing the Select switch.

### 5.17.7 CHANNEL PARAMETERS

*NOTE: If “PASSWORD” is briefly displayed when attempting to select a parameter, see Section 5.17.3.*

The “CHAN PARMS” menu parameter selects the following conventional channel parameters that can be reprogrammed. Press Select switch to select the “CHAN PARMS” parameter and then rotate that switch to display the desired parameter. Then press the Select switch again to select it. The squelch control

parameters are unique to the type of conventional channel selected (analog or Project 25).

*NOTE: If a mixed mode channel is selected, both the Rx Code (analog) and Rx NAC (P25) which follow can be programmed. In addition, if the Tx Type is Analog, a Tx Code is programmed, and if it is Digital (P25), a Tx NAC is programmed.*

**RX FREQ** - Programs the receive channel frequency. To select the digit to change or move the cursor to the right, press the Select switch. Then to display the desired digit, rotate the Select switch. The frequency is stored after programming the last digit. If an invalid frequency is entered, a beep sounds, “INVALID” is briefly displayed, and the frequency editing mode continues to be selected.

**TX FREQ** - Selects the transmit frequency the same the preceding RX FREQ.

#### CTCSS/DCS Squelch Control (Analog Channel)

**RX CODE** - Sets the receive Call Guard (CTCSS/DCS) code. The currently selected code is initially displayed. If required, rotate and press the Select switch to select the desired code type (CTCSS analog or DCS digital). Then enter the desired code similar to programming a receive frequency as just described. If an invalid code is entered, a beep sounds, “INVALID” is briefly displayed, and the editing mode continues to be selected.

**TX CODE** - Selects the transmit codes the same as RX CODE above.

#### NAC Squelch Control (Project 25 Channel)

**RX NAC** - Selects the receive Network Access Code (NAC) which can be any number from 0-4095. With later models, this number is displayed in hexadecimal from 000-FFF. Rotate and press the Select switch to enter the desired code. The displayed code is stored after the last digit is programmed. If an invalid code is entered, a beep sounds, “INVALID” is briefly displayed, and the NAC editing mode continues to be selected.

**TX NAC** - Selects the transmit NAC the same as RX NAC above.

**TX POWER** - Selects the desired power output level. Rotate the Select switch to scroll through the following choices. When the desired setting is displayed, store it by pressing the Select switch.

- **POWER High** - High transmit power
- **POWER Low** - Low transmit power
- **POWER SW** - Switchable power selectable by the High/Low power switch. This choice is not available if that switch is not programmed.

**TX TIMER** - Enables or disables the time-out timer on the current channel. Rotate the Select switch to toggle between the on and off mode, and when the desired setting is displayed, store it by pressing the Select switch.

**Channel Alias\*** - Programs the alias for the channel. Up to ten characters from A-Z and 0-9 and spaces can be entered. Press Select switch once to display the current alias and then press it again or rotate it to program a new alias. Rotate the Select switch to display the desired character and then press it to move to the next position. The number is stored after the Select switch is pressed with the last position selected.

*NOTE: The next two parameters are programmed only if the radio is programmed for encryption.*

**Strapping\*** - Selects the encryption strapping mode for the channel as Clear, Secure, or Switched.

**Key Select\*** - Selects the encryption key for the channel if applicable. The key storage location of 0-15

(PID) or 1-16 (SLN) is selected (see Section 11.2.3). If no keys are programmed, “No Keys” is displayed.

**CHAN SPACE (Analog Only)** - Selects either wide or narrow band channel spacing on analog channels only. Rotate the Select switch to toggle between “WIDE” and “NARROW”, and when the desired setting is displayed, store it by pressing the Select switch.

*NOTE: The channel spacing is not set with P25 channels because it is always narrow, and the squelch cannot be changed because the setting is critical for proper receiver operation.*

**SQ ADJUST (Analog Only)** - Changes the preset squelch setting on that channel. The default setting is “0” and values of -7 to +7 can be selected. Increasing this setting toward +7 causes the squelch to open sooner so that weaker signals can be received, and decreasing it toward -7 causes the opposite to occur.

**TG ID (P25 Only)** - Selects the talk group for the selected channel. Rotate the Select switch to display the alias of each preprogrammed talk group and then press it to store the desired talk group.

**Transmit Type (P25 Mixed Mode Only)** - If the selected channel is a mixed mode, analog and P25 channel, this selects the transmit type. Either Analog or Digital (P25) can be selected. This then determines if a Tx Code or Tx NAC is programmed above.

\* This feature requires firmware Version 1.28/2.6/3.6/4.2 or later.

## SECTION 6 SMARTNET/SMARTZONE/P25 TRUNKED FEATURES

### 6.1 INTRODUCTION

An overview of the SMARTNET/SmartZone and P25 trunked operating modes is located in Section 3.7. The following information describes the features unique to these modes of operation. Refer to the “Radio Wide Features” section starting on page 18 for information on features common to all operating modes.

### 6.2 ANALOG AND DIGITAL OPERATION

Either analog or digital operation can be selected for communication on SMARTNET traffic channels. Each talk group can be programmed for either type of operation. Digital operation may be an optional feature.

### 6.3 VIEWING UNIT ID

When power is turned on with a SMARTNET/SmartZone channel selected, the five-digit Unit ID from 1-65,535 is briefly displayed as IDxxxxx. When a P25 channel selected, the eight-digit unit ID from 1-16,777,216 is displayed (see Section 5.16.1).

### 6.4 STANDARD GROUP CALLS

#### 6.4.1 INTRODUCTION

Standard calls are between you and another mobile, group of mobiles, or a control station (a radio in a fixed location). Most calls are probably this type. Proceed as follows to place and receive group calls:

#### 6.4.2 PLACING A STANDARD GROUP CALL

1. Turn power on and set the volume as described in Section 3.1. Select the channel programmed for the talk group you want to call (see Section 3.4.2).
2. If the talk group is programmed for encryption and is not strapped to Clear or Coded, select the desired mode by pressing the C/S (Clear/Secure) option switch. The status of that switch is ignored if the talk group is strapped to Clear or Coded. Refer to Section 11.3 for more information.

3. Press the PTT switch and begin talking. An optional talk permit tone may sound to indicate when talking can begin. Other indications that may occur are as follows:

- If in the secure mode and your radio is not programmed with the proper encryption key, “KEYFAIL” is displayed and the call must be made in the clear mode or the proper key must be programmed.
- If the busy tone sounds and “BUSY” is displayed, the system is busy. Release the PTT switch and wait for the call back tone to sound. Then press the PTT switch within 3 seconds.
- If a continuous tone sounds and “NO SYS” is displayed, you may be out-of-range. Drive closer or away from shielding objects and try again.
- If your unit ID is invalid, the call is being made to an invalid group ID, or group calls are not enabled, “DISABLED ID” is displayed and an alert tone sounds.
- If an attempt is made to change an analog channel from the clear to the secure mode and there is no available secure channel, “NO SEC” is flashed, an error tone sounds, and the call is terminated.
- If an attempt is made to change an analog channel from the secure to clear mode, “SEC ONLY” is displayed, an error tone sounds, and the call is terminated. (Calls on digital channels can be changed if they are not strapped to clear or secure).
- If the Secure mode is selected by the C/S (Clear/Secure) option switch and an attempt is made to transmit on a channel strapped as Clear, “Clear Only” is displayed and the transmitter is disabled. Likewise, if the Clear mode is selected and the channel is strapped as secure, “Secure Only” is displayed and the transmitter is disabled.

#### 6.4.3 RECEIVING A STANDARD GROUP CALL

Calls are received on only the talk group and/or announcement group programmed for the selected



channel (with scanning disabled). When the selected channel is programmed with both Talk and Announcement groups, only the Talk and Announcement group IDs are detected. Other IDs in the Announcement group are detected only if no talk group is programmed.

When a group call is received, the alias of the selected channel is displayed. The radio can be programmed so that the following are also displayed for 0.5-7.0 seconds or continuously during the call.

**PTT ID-** The unit ID of the mobile placing the call is displayed.

**TG on Rx -** The alias of the talk group on which the call is being received is displayed.

**User Group ID\*** - If the group ID of the call being received is included in a preprogrammed User Group ID list, the alias programmed in that list for that group is displayed.

## 6.5 PRIVATE (UNIT-TO-UNIT) CALLS

*NOTE: With P25 Trunked operation, these calls are called Unit Calls, and they function the same as the Enhanced Private Conversation mode described in the following information.*

### 6.5.1 GENERAL

Private calls allow calls to be placed to a specific mobile unit. Either the Enhanced Private Conversation™ or standard Private Conversation modes may be programmed depending on the capabilities of the radio system. One difference between these call types is that the Enhanced type provides an indication that the called mobile is not on the air and the standard version does not. Operation in each of these modes is described in the following information.

The CALL option switch is required to place these calls, and either that switch or the RESP (Response) switch is required to receive them. Private calls are programmed to operate in one of the following modes:

- Disabled
- Answer-only capability

\* This feature requires firmware 1.24.1/2.2.1/3.2.1/4.2 or later.

- List only - Unit IDs can be selected from a preprogrammed list only (direct entry as follows is not allowed)
- Unlimited - Unit IDs can be selected from a list and also dialed directly using the front panel controls\*\* or the HHC keypad (later units only).

### 6.5.2 PLACING AN ENHANCED PRIVATE CONVERSATION CALL

#### Recalling From A List

1. Momentarily press the CALL (Private/Unit Call) option switch. The tag (alias) of the last called mobile is displayed.
2. To select another mobile, rotate the Select switch until the alias for the desired mobile is displayed.
3. Press the PTT switch and one of the following events then occurs:

*(Proceed to the bulleted list which follows Item 6 in the next section for events that may occur next.)*

#### Direct Entry Using Front Controls or HHC Keypad

4. Press and hold the Private Call option key until a tone sounds (approximately 1 second). The last ID called is displayed.
5. If using the front panel controls, enter the ID of the radio you are calling (five digits must be entered) by rotating and pressing the Select switch. With the HHC, enter the number using the DTMF keypad. To cancel the call, press the Private Call Option key again.
6. Press the PTT switch to initiate the call. If the entered number is valid, the display indicates the alias of the ID if it matches an ID in the call list. Otherwise, the ID you entered continues to be displayed.

Events that may then occur are as follows:

- If the mobile being called is on the air, "WAIT" is displayed and ringing is heard until the called party answers or for 20 seconds, whichever occurs first. Pressing the PTT or an option switch stops

\*\* This feature requires firmware Version 1.28/2.6/3.6/4.2 or later.

the ringing but not the call. When the call is answered, the voice of the called party is heard.

- If the called mobile does not answer within 20 seconds, a continuous tone sounds and “NO ANS” is displayed.
  - If the called mobile is not on the air, a continuous tone sounds instead of the ringing tone and “NO ACK” is displayed.
  - If the busy tone sounds and “BUSY” is displayed, the called mobile has answered the call but the system is busy. When the system is no longer busy, the call back tone sounds.
  - If your radio or the called radio is inhibited or not programmed to make this type of call or for the requested secure mode, “RSPNS ONLY” is displayed and an alert tone sounds.
  - If your radio does not have the proper encryption key, “KEYFAIL” is displayed and the call must be made in the clear mode by pressing the C/S (Clear/Secure) option switch (if encryption is selectable on the channel). Otherwise, the correct key must be loaded.
7. When the call is finished or is not answered, end it by pressing the CALL option switch and placing the microphone back on-hook.

### 6.5.3 PLACING A STANDARD PRIVATE CONVERSATION CALL

#### Recalling From A List

1. Momentarily press the CALL (Private Call) option switch. The tag (alias) of the last called mobile is displayed.
2. To select another mobile, rotate the Select switch until the tag for the desired mobile is displayed.
3. Press the PTT switch to initiate the call.

*(Proceed to the bulleted list which follows Item 6 in the next section for events that may occur next.)*

#### Direct Entry Using Front Controls or HHC Keypad

4. Press and hold the Private Call option key until a tone sounds (approximately 1 second). The last ID called is displayed.
5. If using the front panel controls, enter the ID of the radio you are calling (five digits must be entered) by rotating and pressing the Select switch. With the HHC, enter the number using the DTMF keypad. To cancel the call, press the Private Call Option key again.
6. Press the PTT switch to initiate the call. If the entered number is valid, the display indicates the alias of the ID if it matches an ID in the call list. Otherwise, the ID you entered continues to be displayed.

Events that may then occur are as follows:

- The called party answers the call.
  - The called party does not answer. Press the CALL option switch to end the call.
  - If the selected mobile ID is not valid, “INVALID ID” is displayed and an alert tone sounds.
  - If the radio system is busy, four low tones sound and “BUSY” is displayed. When the system is no longer busy, the call back tone (four beeps) is heard and the channel is automatically acquired. Press the PTT switch to continue the call.
  - If the call is in the secure mode and your radio does not have the proper encryption key, “KEYFAIL” is displayed and the call must be made in the clear mode by pressing the C/S (Clear/Secure) option switch (if encryption is selectable on the channel). Otherwise, the correct key must be loaded.
7. When the call is finished or if it is not answered, end it by pressing the CALL option switch and placing the microphone on-hook.

#### 6.5.4 RECEIVING A PRIVATE CALL (ALL TYPES)

1. When a private call or unit call is received, “CALL RCVD” is displayed and the call tone sounds once.
2. To answer the call, press the **CALL** (Private/Unit Call) option switch and then the **PTT** switch and begin speaking. The unit ID of the calling mobile is displayed. More information follows:
  - If the **PTT** switch is pressed before the **CALL** switch, the call is transmitted as a group call.
  - If private calls are not permitted (**CALL** switch not programmed) press the **RESP** (Call Response) option switch to respond.
  - The call must be answered within 20 seconds or it is automatically terminated.
  - If the system is busy when a response is made, “BUSY” is displayed and the busy tone sounds.

### 6.6 TELEPHONE CALLS

*NOTE: In the P25 trunked mode, telephone calls are available only with firmware Version 1.28/2.6/3.6/4.2 or later.*

#### 6.6.1 GENERAL

The telephone call feature\* allows telephone calls to be placed and received over the public telephone system using your radio. The type of call (secure/clear) is determined by the mode selected by the **C/S** (Clear/Secure) option switch. Telephone calling is programmed to operate in one of the following modes:

- Disabled (telephone calls not available)
- Answer-only capability
  - List only - Telephone numbers can be selected from a preprogrammed list only (direct entry as follows is not allowed)
  - Unlimited - Telephone numbers can be selected from a list and also dialed directly\*\* entered using the front panel controls or the **HHC** keypad (later units only).

\* This feature requires firmware Version 1.20.0/2.0/3.0/4.2 or later.

#### 6.6.2 PLACING A TELEPHONE CALL

##### Recalling From A List

1. With a SMARTNET/SmartZone channel selected, momentarily press the **PHONE** option switch. The tag (alias) of the last called telephone number is displayed.
2. If required, rotate the **Select** switch to display the desired number. The tag of each number is displayed.
3. Press and then release the **PTT** switch and “DIALING” is displayed. Refer to the bulleted list following step 6 in the next section for events that may then occur.

##### Direct Entry Using DTMF Keypad

4. Press and hold the **PHONE** option switch until a tone sounds (approximately 1 second). The alias of the last called telephone number is displayed if it is in the phone number list. Otherwise, the last ten digits of the last called telephone number are displayed. The phone call mode is indicated by  in the display.
5. If using the front panel controls, enter the telephone number by rotating and pressing the **Select** switch. The 0-9, the \*, #, and P (pause) characters can be entered (# is displayed as a “+”). Numbers up to sixteen digits (including pauses) can be entered, and the number scrolls to the left in the display so that the ten right-most digits are always displayed. With the **HHC**, enter the number using the **DTMF** keypad (a pause indicated by “P” is entered by \* #).
6. Press and release the **PTT** switch and “DIALING” is displayed. Events that may occur are as follows:
  - If the access is successful, a dial tone sounds and the dialed number is displayed and sent. Either ringing or a busy signal is then heard as with a standard telephone call. When the called party answers, press the **PTT** switch to talk and release it to listen (since the radio operates half-duplex, it is not possible to talk and listen at the same time).

\*\* This feature requires firmware Version 1.28/2.6/3.6/4.2 or later.

Each time the PTT switch is released, a go-ahead tone is sent to the landside party to indicate when they can respond. To dial a number after the connection is made, press the PTT switch and dial the number using the microphone keypad (if available).

- If the selected telephone number is not valid, “INVALID” is displayed and an alert tone sounds. Select a valid number.
  - If the system is busy, “BUSY” is displayed and the busy tone sounds. The call automatically proceeds when the system becomes available.
  - If you are out-of-range or the radio cannot be accessed for some reason, “NO PHONE” is displayed and an alert tone sounds.
  - If the interconnect call you are making or the selected secure mode is not authorized, “REJECT” is displayed and an alert tone sounds.
  - If your radio does not have the proper encryption key, “KEYFAIL” is displayed and the call must be made in the clear mode by pressing the Clear/Secure option key (if strapped to switchable). Otherwise, load the correct key.
7. When the telephone call is finished or it could not be completed for some reason, end it by pressing the PHONE option switch and placing the microphone back on-hook.

### 6.6.3 RECEIVING A TELEPHONE CALL

1. When a telephone call is received, “ringing” similar to a standard telephone is heard and “PHONE” is displayed.
2. To answer the call, press the PHONE option switch and press the PTT switch to talk and release it to listen (since the radio operates half duplex, it is not possible to talk and listen at the same time).
3. When the call is finished, end it by pressing the PHONE option switch and placing the microphone back on-hook.

## 6.7 CALL ALERT

The Call Alert™ feature allows pages to be sent and received. With SMARTNET/SmartZone operation, either the Enhanced Private Conversation™ or Standard Private Conversation mode may be programmed depending on the capabilities of the radio system. With P25 Trunked operation, operation is similar to the enhanced mode.

### Answering a Page

1. When a page is received, five beeps sound and “PAGE” is displayed. The ID of the mobile paging you is stored as the last ID received.
2. To clear or ignore the page, press any option switch. If the PTT switch is pressed, a group call is placed on the selected channel.
3. To answer the page as a private or unit call (see page 41), press the CALL (Private/Unit Call) option switch and the tag (alias) of the mobile paging you is displayed. Press the PTT switch and respond. One of the conditions that follow may also occur:

### Enhanced Private Conversation™ Mode

- If the mobile being called is on the air, ringing is heard until the called party answers or for 20 seconds, whichever occurs first. If no answer occurs within 20 seconds, a continuous tone sounds and “NO ANS” is displayed.
- If the mobile being called is not on the air, a continuous tone is heard instead of ringing and “NO ACK” is displayed.

### Standard Private Conversation Mode

- If the mobile being called is not on the air or does not answer, you will simply not hear a response.
4. When the call is finished or it could not be completed for some reason, end it by pressing the CALL option switch and placing the microphone back on-hook.

### Initiating a Page

1. With a SMARTNET/SmartZone or P25 trunked channel selected, momentarily press the **ALERT** option switch. The tag (alias) of the last ID called is displayed.
2. If required, rotate the Select switch to display the desired mobile. The tag of each number is displayed.
3. Press the PTT switch and one of the following then occur:
  - If five beeps sound, the system received the page and the paged mobile is on the air and received it. The page mode is automatically exited.
  - If the system received the page but the called mobile is not on the air, a single beep sounds and “NO ACK” is displayed 6 seconds after the PTT switch is pressed. Auto exit then occurs.

## 6.8 MESSAGING

*NOTE: This feature is not available with P25 trunked operation.*

The messaging feature allows preprogrammed messages to be sent to your dispatcher. Up to 16 messages can be preprogrammed, and they are identified by an alias. If an **MSG** option switch is programmed, messages are sent as follows:

1. Momentarily press the **MSG** option switch. The alias of the last message sent is displayed.
2. If required, rotate the Select switch to display the desired message. Then send the message by momentarily pressing the PTT or Select switch. One of the following then occurs:
  - If five beeps sound and “ACK RCVD” is displayed, the message was received and automatically acknowledged by the system.
  - If after five tries the message is not acknowledged, a tone sounds and “NO ACK” is displayed.

## 6.9 SENDING STATUS CONDITIONS

The status feature allows you to manually or automatically send your current status to your dispatcher. Up to eight status conditions can be preprogrammed, and they are identified by a tag (alias). If the **STATUS** option switch is programmed, status conditions are sent as follows:

1. Momentarily press the **STATUS** option switch. The tag of the current status condition is displayed.
2. To change the current status, rotate the Select switch or press the PTT switch until the desired status is displayed. Then press the Select switch to accept that status. One of the following conditions then occurs:
  - If five beeps sound and “ACK RCVD” is displayed, the status was received and acknowledged by the system.
  - If after five tries the message is not acknowledged, a tone sounds and “NO ACK” is displayed.

## 6.10 EMERGENCY ALARM AND CALL

*NOTE: The following enhanced conventional emergency features require 5300 firmware 1.21.0/2.0/3.0 and PCConfigure 1.19 or later.*

### 6.10.1 INTRODUCTION

Emergency Alarms and Calls are separate functions that can be individually enabled or disabled on each SMARTNET/SmartZone and P25 Trunked system. The Emergency option switch is required for these functions. Other emergency features are as follows:

- Emergency Alarms are transmitted on the selected talk group if emergency calls are disabled, and on the emergency talk group if emergency calls are enabled.
- Emergency Call talk group selection priority is as follows. For example, if a global emergency channel is not programmed, the emergency talk group of the selected channel is used and so on.

1. Global (radio wide) emergency channel
  2. Emergency group of the selected channel
  3. Talk group of the selected channel
  4. Announcement group of the selected channel
- The emergency programming of the system to which that emergency talk group is linked controls the emergency operation.

## 6.10.2 EMERGENCY ALARMS

An emergency alarm is a special transmission that alerts a dispatcher of an emergency situation. It is sent automatically by simply pressing Emergency option switch. The system to which the emergency channel is linked must have Emergency Alarms enabled. If not, Emergency Alarms are disabled. The alarm is sent on the control channel using Motorola proprietary signaling.

Proceed as follows to send an emergency alarm:

1. If required, select a channel of a system on which Emergency Alarms are enabled and then press the EMER option switch. The radio then automatically transmits the emergency alarm.
2. Either Normal or Silent operation can be programmed. With the Normal mode, the red LED lights, the emergency tone sounds, and “EMERGENCY” flashes in the display. This indication continues to flash until the alarm mode is ended (see step 4). If silent programmed or the Surveillance mode is selected (see Section 4.9), none of these indications occur. If “No Receive Activity During Emergency” is programmed, receive audio, the front panel LED, and receive icons are disabled in the receive mode (firmware Versions 1.28/2.6/3.6/4.2 or later only).
3. When the emergency alarm is acknowledged, “ACK RCVD” is briefly displayed and the emergency acknowledge tone (two beeps) sounds. Silent operation may also be programmed in which case no tone sounds and there is no indication that an acknowledgment occurred.
4. The radio continues to transmit this message until an acknowledgment is received or the programmed

number of attempts have been made. The emergency alarm mode is exited when radio power is cycled, the channel is changed, or by pressing and holding\* the Emergency option switch.

## 6.10.3 EMERGENCY CALLS

### General

An emergency call urgently requests access to a voice channel (an emergency tone usually does not sound at the console). An emergency call is placed by pressing the PTT switch after pressing the Emergency option button. If the Emergency Hot Mic feature is enabled, the emergency call is automatically transmitted without having to press the PTT switch (see following description). The system to which the emergency channel is linked must have Emergency Calls enabled.

### Emergency Hot Mic

If Emergency Hot Mic has been enabled for emergency calls, automatic transmitting occurs with microphone audio unmuted without having to manually press the PTT switch. The automatic transmit period is programmed for 10-120 seconds in 10-second intervals. If this feature or emergency calls are not enabled by programming, automatic transmitting does not occur. This feature is initiated only on the first press of the Emergency switch. Subsequent presses do not trigger automatic transmissions. To reset this function, the channel must be changed or power cycled.

### Placing an Emergency Call

1. If required, select a channel of a system on which Emergency Calls are enabled and press the Emergency option switch. The Emergency Alarm is then sent as described in Section 5.10.2 if applicable.
1. The emergency mode is indicated when “ACK RCVD” is briefly displayed and then “EMERGENCY” and the emergency talk group are alternately displayed.
2. If the preceding Emergency Hot Mic feature is enabled, the call is automatically transmitted without pressing the PTT switch. If it is disabled,

\* This feature requires firmware 1.24.1/2.2.1/3.2.1/4.2 or later.

press the PTT switch and begin speaking as with a standard call.

3. All group calls which follow are then emergency calls (private, telephone, and call alert calls are not allowed). If the channel is changed, the call is made on the emergency talk group programmed for the new channel. If the Surveillance Mode is enabled (see Section 4.9), all indicators, lights, and tones are disabled. If “No Receive Activity During Emergency” is programmed, receive audio, the front panel LED, and receive icons are disabled in the receive mode (firmware Versions 1.28/2.6/3.6/4.2 or later only).
4. To exit this mode, cycle radio power or press and hold\* the Emergency switch.

### 6.11 FAILSOFT OPERATION

If a failure occurs in the SMARTNET/SmartZone or P25 Trunked system so that it cannot be used, the system directs the radio to automatically enter the failsoft mode. When in this mode, “FAILSOFT” and the alias of the selected channel are alternately displayed. A failsoft tone may also be heard, depending on how the repeater is programmed.

When in the failsoft mode, operation is in the conventional mode on the preprogrammed failsoft channel (a different failsoft channel can be programmed on each talk group). If a transmission is attempted before a failsoft channel is located, a continuous tones sounds until the PTT switch is released. When the radio system returns to normal operation, this is automatically detected and normal operation resumes.

### 6.12 SMARTNET/SMARTZONE/P25 TRUNKED SCANNING FEATURES

#### 6.12.1 GENERAL

Scanning on a SMARTNET/Smartzone or P25 Trunked system is called Priority Monitor Scan. The following are unique features of this type of scanning. For general scanning information applicable to all operating modes, refer to Sections 4.11 and 4.12

- Scanning is turned on and off by the SCAN option switch. Talk groups (channels) can be programmed so that scanning automatically starts whenever the talk group is selected (Autoscan).
- When responding to calls in the scan mode, the programming of the Talkback Scan parameter determines if a response always occurs on the talk group of the call (Active Group) or the Selected Group if they are different. Transmissions at other times always occur on the selected talk group.
- Up to 256 scan lists or the number that fit in available memory can be programmed. Each list can include up to 256 talk groups from the same system, one of which can be a priority group as described in the next section.
- If the SCN ED option key is programmed, scan lists are user programmable (see Section 6.12.3). In addition, nuisance channels can be temporarily deleted as described in Section 4.11.6.
- Each talk group is programmed to select one of the programmed scan lists or “No List” (scanning is disabled). If scanning is enabled and the selected channel does not permit scanning, it is automatically enabled again when a channel is selected that permits scanning.
- The selected scan list can be temporarily changed if the Scan (List) Select option switch is programmed. The procedure is described in Section 6.12.3.
- In addition to calls on channels in the scan list, pages, private/unit calls, and telephone calls are received while scanning. Private and telephone calls are not interrupted by priority messages.

#### 6.12.2 PRIORITY TALK GROUP SAMPLING

One talk group in the scan list can be designated a priority talk group by programming or it can be the selected talk group. When scanning, messages on a non-priority talk group are interrupted by messages on the priority talk group. Priority scanning must also be supported at the system level for it to occur as programmed in the radio.

\* This feature requires firmware 1.24.1/2.2.1/3.2.1/4.2 or later.

### 6.12.3 SCAN LIST EDITING AND SELECTION

SMARTNET/SmartZone and P25 Trunked scan lists are user programmable if the **SCN ED** option switch is programmed. The procedure is described in Section 4.12.1.

With SMARTNET/SmartZone and P25 trunked operation, each channel (talk group) can be programmed to select one of the programmed scan lists or so scanning is disabled (No List). In addition, each channel can be programmed so that scanning is automatically enabled (Auto Scan) when it is selected.

If the **SN LIST** option switch is programmed, the list that is selected by all talk and announcement groups in the current system can be temporarily changed by the user as follows. Also selectable if desired is “No List” (scanning disabled) or “Programmed” (default list). The programmed default list is automatically reselected at power up.

Proceed as follows to temporarily change the currently selected scan list:

1. With scanning disabled (the rotating  icon is not indicated in the right status display), press the **SN LIST** option switch.
2. The currently selected list is displayed as “List x”, with “x” the currently selected list. To exit without changing the selected list, simply press the **SN LIST** option switch again.
3. To select another list, “Programmed”, or “No List”, rotate the Select switch. When the desired list is displayed, select it and exit this mode by pressing the Scan List option switch again.

### 6.13 DYNAMIC REGROUPING

The dynamic regrouping feature allows a dispatcher to change the current talk group or switch mobiles to a predefined regrouping channel to receive an important message. When the console issues a regroup order, the radio switches to the preprogrammed regroup talk group.

If the Cancel Dynamic Regrouping option switch is programmed, it can be pressed to exit the dynamic regrouping mode.

Otherwise, if the lock mode was not specified, the selected talk group can be manually changed and the previous talk group is reselected if power is cycled. If a locked regroup command is received, the displayed talk group cannot be changed manually or by cycling power. It can be changed only after a clear order is received from the console.

Dynamic regrouping operates as follows:

1. When this command is received, alternating tones sound and the radio automatically changes to the regrouping channel and “DYN REGRP” is displayed.
2. Manually select the channel corresponding to that tag. If this is not done, transmission still occurs on the new channel, but the alternating tones sound each time the PTT switch is pressed.
3. Talk and listen as usual. When dynamic regrouping is canceled by the dispatcher, a short tone sounds. If a standard channel is not selected after this occurs, transmission is not allowed if the talk group is assigned as a dynamic regrouping talk group only. If it is assigned as a normal talk group, normal transmissions are allowed.

## 6.14 SMARTZONE AND P25 TRUNKING UNIQUE FEATURES

### 6.14.1 INTRODUCTION

As described in Section 3.7.3, the SmartZone<sup>®</sup> mode provides wide area coverage by allowing roaming between SMARTNET and conventional sites. The P25 Trunked mode can provide access to a single trunked site or roaming between several trunked sites. Operation in these modes is the same as just described in the preceding sections (6.1-6.13) with the following additional features:

### 6.14.2 BUSY OVERRIDE

The busy override feature is enabled at the system level by the system manager and is not a programmable radio feature. It allows a call to be placed even if not all of the sites you are calling have a free traffic channel. The only sites guaranteed to be included are the Critical Sites and the sites where a Critical User is located. This feature operates as follows:



1. Assume that you have attempted to place a call and the system was busy (“BUSY” displayed and busy tone sounded).
2. Release the PTT switch and then press it for 5 seconds or more. If a chirp-like tone sounds with the PTT switch pressed, busy override is occurring.

*NOTE: Remember that not all members of the talk group are receiving your message. Missing members will start receiving your message as channels become available.*

### 6.14.3 SITE TRUNKING

Site trunking occurs when a site can no longer participate in wide area trunking. It is disconnected from other sites and only supports calls with other radios on that site and cannot route audio to other sites. When site trunking is occurring, the radio searches for other sites that may provide wide area coverage.

Site trunking ends when a wide area coverage site is located, the current site is operating again as a wide area coverage site, an out-of-range condition occurs, or the failsoft mode is entered. The radio can be programmed so that “Site Trunking” is displayed and/or an alert tone sounds when site trunking occurs.

SmartZone and P25 trunked systems can be programmed for “Disable Site Trunking Operation”. The radio is then not allowed to start or operate on a site trunking site. If a site goes into site trunking, the radio leaves that site’s control channel and attempts to find another valid wide area site. If no wide area site is available, the radio displays “Out-of-Range”. If a site adjacent to the current Home Site was in site trunking but then enters wide area trunking, it is evaluated to determine if it should move to that site as a better site. This feature is available with firmware 1.28/2.6/3.6/4.2 or later only.

### 6.14.4 DETERMINING CURRENT SITE AND SEARCHING FOR A NEW SITE

To display the RSSI level of the current site, press the **SEARCH** option switch. The display then indicates the current site number as “SITE xx” and the RSSI (Receive Signal Strength Indicator) signal level as “RSSI xx”. This mode is then automatically exited.

To scroll through the other programmed sites, press and hold the **SEARCH** option switch while “Site xx” or “RSSI xx” is displayed. If site lock is on when site search is entered (see following), the radio will be locked on the new site when this function is exited.

### 6.14.5 LOCKING/UNLOCKING A SITE

It is sometimes desirable to stay on a site. To prevent the radio from searching for a new site, lock it on the current site by pressing the **LOCK** option switch. The display then momentarily indicates the site alias to indicate that the current site is locked (“x” is the current site number). To unlock the site, press the **LOCK** option switch again and “UNLOCK” is momentarily displayed.

### 6.14.6 ZONEFAIL SITE LOCK

This is an optional feature that can be enabled only by factory programmed. It is not programmed by the PCConfigure software, and does not require any special inputs from the infrastructure to operate. This feature is intended to prevent some of the confusion resulting from a site controller failure. When this occurs, all sites go into the Site Trunking mode and radios continue to roam normally according to RSSI level. The result is that the various radios selected by a particular talk group may be operating on different sites and are unable to talk to each other (see Section 6.14.3 for more Site Trunking information).

With the Zone Fail Site Lock feature enabled, the radio continues to roam normally when the system zone controller is active. However, if the zone controller fails, this is detected and the Zone Fail Site Lock mode is entered. The only site the radio is then allowed to operate on is its home site. If its home site is not available, “Out-of-Range” is displayed. A zone controller failure is detected by determining that every site in the dynamic site list is in Site Trunking. Currently, this condition must be detected for at least 1 minute for the Zone Fail Site Lock mode to be selected.

The result of this operation is that all radios with the same programmed home site are forced to the home site to communicate which ensures that they can continue to communicate. If the home site is not available, the Out-of-Range condition tells the user to

attempt communication on another system or by some other means.

#### 6.14.7 P25 WIDE AREA SCAN

##### Introduction

This feature is intended to enhance roaming performance, especially when system level steering via radio or talk group permissions is used.

##### Normal P25 and SmartZone Control Channel Hunt

The following control channel search methods are normally used to find a control channel:

**Short Hunt** - The dynamic array of 7 (or 15) adjacent sites is searched. This list is saved on power down and loaded again at power up. It is erased whenever parameters are downloaded to the radio by the PCConfigure programmer.

**Long Hunt** - If no valid control channel is located by the preceding short hunt method, the radio searches the list of control channels programmed into the radio by the PCConfigure programmer.

**Full Spectrum CC Scan** - If the two preceding methods do not locate a control channel, every channel available to the radio is searched.

##### Talkgroup Steering Via System Access Permissions

In order to use system channel resources more efficiently, some system operators are using system access permissions to steer certain talkgroups to particular sites. For example, a police department may be allowed to use only Site 1, and a public works department may be allowed to use only Site 2.

The problem with this operation is that every time a different talk group is selected, the access permission may be different and a different site may need to be accessed. This could result, in a worst case, in a delay

of up to 30 seconds in finding a new site. This could occur if there are no valid sites for the new talk group in the dynamic site list.

##### P25 Wide Area Scan

A feature called Wide Area Scan can be programmed to minimize the problem just outlined. This feature is programmed on the Talk Group list screen selected on the P25 System screen. When Wide Area Scan is selected, talk group site preferences are no longer available. However, System Site Preference lists can still be used. The Wide Area Scan feature functions as follows:

1. Assume TG1 is selected. If it is the first time this talk group is selected, normal searching for a control channel occurs according to the hunt methods previously described.
2. When another talk group is selected, the active valid site for TG1 is stored in EEPROM memory.
3. The next time TG1 is selected, the following procedure is performed before performing the normal hunt methods previously described.
  - a. The last valid site ID and its receive and transmit channel numbers are loaded from EEPROM memory.
  - b. The dynamic site list is checked to see if any newer receive/transmit channel information is available for the last site ID.
  - c. The best receive/transmit information is used and the radio checks to see if this control channel is available.

The result of the preceding operation is that the radio has a reasonable chance of finding a valid site, usually on the first try. This greatly reduces access time, even on systems which have highly restricted talk group based access.

## SECTION 7 MISCELLANEOUS

### 7.1 SUPERVISORY TONES

#### Single Beep (Alert Tone)

- Power was turned on and a successful power-up sequence occurred (see “Turning Power On and Setting Volume” on page 13).
- The time-out timer is about to expire or the penalty timer has expired (page 19).
- The conversation timer is about to expire (page 27).
- The system received your page but the paged mobile is not on the air (page 44).
- Telephone interconnect is not operational (page 43).

#### Continuous Tone (Invalid Condition)

- A transmission is being attempted on a conventional channel programmed as receive-only.
- The transmitter is disabled by the transmit disable on busy feature (page 26).
- The transmitter has been disabled by the time-out timer feature (page 19).
- The transmitter has been disabled by the conversation timer (page 27).
- An out-of-range condition exists (SMARTNET/SmartZone only).
- A transmission is being attempted before the penalty timer has expired (page 19).
- Dynamic regrouping has been exited but the dynamic regrouping channel is still selected (page 48).

#### Single Short Medium-Pitch Tone

- A valid key has been pressed.

#### Single Short Low-Pitch Tone

- An invalid key has been pressed.

#### Medium Tone (No Acknowledge)

- The paged mobile did not acknowledge the page (page 44).

- The message that was sent has not been acknowledged (page 45).
- The status condition that was sent has not been acknowledged (page 45).

#### Five Beeps (Recurring)

- The page was received (page 44).

#### Two Short Tones

- A unit-to-unit call was received (page 41).

#### Five Beeps

- The paged mobile received the page and acknowledged it (page 44).
- The message that was sent has been received and acknowledged (page 45).
- The status condition that was sent has been received and acknowledged (page 45).

#### Four Beeps

- The emergency alarm condition was acknowledged (page 45).
- Four low beeps indicate the call back mode (the system is no longer busy).

#### Alternating Tone

- Dynamic regrouping has occurred (page 48).
- Dynamic regrouping has occurred but the regrouping channel is not selected (page 48).

#### Busy Signal

- The radio system is busy or a busy condition exists when making a telephone call.

#### Three Medium Pitch Tones

- A channel is available after a busy condition occurred (SMARTNET/SmartZone only).

## 7.2 ERROR MESSAGES

The following are definitions of the various error messages that may be displayed.

**Aff Failed** - A group affiliation attempt has received a FAILED response from the system. The precise reason for a FAILED response is manufacturer dependent.

**Aff Deny** - A group affiliation attempt has received a DENIED response from the system. The precise reason for a DENIED response is manufacturer dependent. One common cause is that the group is disallowed on the site/RFSS that the radio is attempting to affiliate on.

**Aff Refused** - A group affiliation attempt has received a REFUSED response from the system. The precise reason for a REFUSED response is manufacturer dependent.

**Answer Only** - The user has attempted to initiate a private call or interconnect call and the feature is programmed for answer only.

**Bad Band** - A profile/or user parameters have been downloaded with PCConfigure that are for a band different from the hardware of the radio.

**Bad ESN** - The ESN of the radio is not valid. This error is usually only seen in the factory when first programming brand new logic boards.

**Bad Fl Fmt** - A profile/or user parameters have been downloaded to the radio that do not match the file format supported by the firmware/software in the radio.

**Bad Hrdwar** - The ESN of the radio is not valid. This error is usually only seen in the factory when first programming brand new logic boards.

**Batt Low** - The battery voltage has been detected as being low.

**Busy** - A call has been attempted and the system has responded that no channels are available for assignment.

**Busy Tmout** - The radio previously received a busy response from the system and it has not received a

channel grant before the busy time-out timer has expired

**Disabled** - The selected channel is disabled.

**Clear Only** - The selected channel or group is strapped clear only and that a secure call can not be made.

**Corrupt Prm** - The radio has detected that its profile/user parameters are not valid because the functional blocks can not be identified.

**Denied** - A group call attempt has received a DENIED response from the system.

**Deny** - A unit or interconnect call attempt has received a DENIED response from the system.

**Disabled** - The feature that the user is attempting to use has been disabled on the radio either by programming or by factory options.

**DSP Failed** - The main processor and the DSP have failed to complete their startup procedure at powerup.

**EEPRM Fail** - The main processor has timed out while trying to validate or invalidate the profile/user parameters in the EEPROM.

**Encryp Bad** - The main processor and the Encryption Module have failed to complete their startup procedure at power up.

**Fixed High** - The selected channel or group is strapped to high power and thus low power can not be selected.

**Fixed Low** - The selected channel or group is strapped to low power and thus high power can not be selected.

**Too Hot** - The mobile has passed the hot temperature threshold. Under these conditions the radio will only transmit in low power.

**Invalid** - The received input from the user does not fit the criteria necessary for the feature.

**Invalid ID** - The received ID from the user was not a valid ID.

**Invalid Key** - The key pressed by the user was not valid for the current situation.

**Invalid Ch** - The channel entered by the user in keypad programming is not valid.

**Key Fail** - The encryption key required by the current selected group/channel is not valid.

**Keypad Lockd** - The keypad lock function is active and key presses are not accepted in this mode.

**Kset Fail** - The encryption key set chosen by the user is not valid.

**List Only** - Direct entry of a unit ID or phone number is disabled.

**Locked** - A selector lock command has been received and zone and channel changes are not accepted.

**Lost Signal** - Signal from the infrastructure has been lost during an interconnect call.

**Low Power** - The current channel is strapped to low power and that the user can not select high power at this time.

**Msg Failed** - The current channel is strapped to low power and that the user can not select high power at this time.

**Narrow** - The current conventional channel is programmed as a narrow channel.

**No Ack** - The radio did not receive an ACK for the current signaling attempt.

**No Edit** - The current list is not able to be edited.

**No Encrypt** - Encryption is not available for the selected channel.

**No List** - No list is available for the selected channel.

**No Message** - No message is programmed for transmission.

**No Reply** - Radio cloning failed due to no response.

**No Service** - OTAR service is not available.

**No Site** - No site with a verified ID is yet on the dynamic site list.

**No Keys** - No keys are available for the key select function.

**Out Of Rng** - This error indicates no control channel has been found for trunking operation.

**Parms Fail** - The checksum of the profile / user parameters does not match the calculated checksum. This indicates that there is an error in the parameters file. This message only occurs if the redundant copy of the parameters is also corrupt or is unable to be used.

**Rekey Fail** - This error indicates a failure in a rekeying process.

**Rx Only** - The selected channel is Rx only.

**Sts Failed** - No acknowledgement was received while sending a status report.

**Timeout** - A time out has occurred in attempting the current function.

**Too Hot** - The mobile has passed the TOO HOT temperature threshold. Under these conditions the radio will not allow Tx.

**Tx Timeout** - The Tx time-out timer has expired and Tx has been terminated.

**VOLTAGE HI** - The input voltage to the mobile is too high.

**VOLTAGE LO** - The input voltage to the mobile is too low.

**Write Fail** - The radio is unable to write to the EEPROM.

### 7.3 SYSTEM OPERATOR PROGRAMMING

As noted several times in this manual, programming determines the availability and specific operation of many features. This usually refers to the program-

ming performed by your system operator when the radio was set up, not to any programming that a user can perform. If a feature is controlled by a front panel option switch and that switch is not available, it is probably not available.

An exception is Keypad Programming which can allow the user to reprogram several conventional channel parameters. Refer to Section 5.17 on page 36 for more information.

#### 7.4 SPEAKING INTO MICROPHONE

For best results, hold the microphone about 1-2 inches from your mouth and speak at a normal conversational level. Do not shout since it distorts your voice and does not increase range. Make sure that the PTT (push-to-talk) switch is pressed before you begin to speak and released as soon as the message is complete.

#### 7.5 OPERATION AT EXTENDED RANGE

When approaching the limits of radio range, the other party may not be able to hear your transmissions and there may be an increase in background noise when messages are received. You may still be out of range even though you can hear a message. The reason for this is that the signal you are receiving is usually transmitted at a higher power level than the one transmitted by your radio. Communication may be improved by moving to higher ground or away from shielding objects such as tall buildings or hills.

#### 7.6 PREVENTING BATTERY DISCHARGE

In the standby mode (power on, not transmitting), radio power consumption is relatively low. Therefore, you can probably leave the radio on for one or two days without operating the vehicle and the battery should not become seriously discharged. However, if the outdoor temperature is low enough to significantly decrease battery capacity, the radio should be turned off when not in use.

Since power consumption is significantly higher when transmitting, it is good practice to have the

vehicle running while transmitting. This ensures that optimum power is being delivered to the radio and that the battery does not become discharged.

#### 7.7 LICENSING

A government license is usually required to operate this radio on the air.

#### 7.8 RADIO SERVICE

If “UNPROGRAMD” is displayed, the cause could be any of the following:

- An unprogrammed channel is selected. Select a programmed channel.
- The selected channel is programmed for an option that is not installed or an error in programming was detected. Contact your system operator for service.

If no characters or all characters appear in the display, the viewing angle may be improperly adjusted. Refer to Section 3.3 on page 14 for more information.

If some other problem is occurring, turn power off and then on again to reset the control logic. Also make sure that the controls are properly set and that the power, external speaker, and accessory cables (if used) are securely plugged into the back of the radio.

If the radio is completely inoperative, check the power cable fuse that is usually located near the vehicle battery. If it is blown, remedy the cause if possible and replace it with the same type (15A). If the radio still does not operate properly, return it to your system operator for service.

*NOTE: There are no user-serviceable components in the radio. Altering internal adjustments can cause illegal emissions, void the warranty, and result in improper operation that can seriously damage the radio.*

## SECTION 8 DETERMINING AVAILABLE OPTIONS

### 8.1 GENERAL

This manual describes the operation of all features that are currently available for the 5300 radio. However, many of these features are optional and therefore may not be available in your radio. For example, Project 25 trunked operation is optional and may not be available.

Availability of optional features is controlled by factory programming of the control logic. Only those features that are specifically ordered and enabled in a particular radio are available for use and can be programmed. The features controlled by factory programming are as follows:

#### P25 Options

- P25 conventional mobile data
- P25 trunked mobile data
- P25 conventional operation
- P25 trunked operation

#### Encryption Options

- DES
- DES-XL
- DES-OFB
- AES [1]

#### OTAR Options

- OTAR P25 conventional
- OTAR P25 trunked

#### Trunking Options

- STAR roaming with P25 trunked operation
- SMARTNET analog operation
- SmartZone analog operation
- Digital SMARTNET/SmartZone
- Multi-Net operation

#### Feature Options

- Keypad programming (Federal Gov't users only)
- 512 channels/talk groups (5100 only, currently standard)

- DTMF Keypad support (5100 only)
- Zonefail site lock

[1] AES encryption is available only with ARM code 1.20.0 or later (and all 2.0/3.0/4.0 versions).

Currently, the only operating mode that is standard with all models is the conventional analog mode. Other variables such as frequency range are hardware dependent instead of software dependent.

### 8.2 UPGRADING A RADIO WITH NEW OPTIONS

The capability exists to upgrade radios in the field with new features. A new feature can be purchased and a special encrypted code string keyed to the ESN (Electronic Serial Number) of the radio is then provided by the E.F. Johnson Company. This string is in the form of a computer file, and is downloaded to the radio using the PCConfigure programming software. This is initiated by clicking the "Update Options" button on the Radio Options screen shown in Figure 8-1.

### 8.3 USING PCCONFIGURE TO DETERMINE OPTIONS

To determine what software options have been enabled in a particular radio, it is recommended that you use the PCConfigure™ programming software to read and display what options are installed. Proceed as follows:

1. Connect the computer to the radio and start the program as described in the documentation included with the PCConfigure software.
2. Select the 5300 radio type by selecting menu parameter **Radio > Series > 5300 Mobile**.
3. To display the Radio Options screen shown in Figure 8-1, select **Transfer > Read Options From Radio**.
4. The check boxes indicate which options are enabled in the radio. They are for informational purposes only and cannot be edited.

Examples

The following are examples of items that need to be checked to program various optional features:

**P25 Conventional Operation with DES Encryption and OTAR**

- P25 Options - Digital Conventional, Conventional Mobile Data
- Encryption Options - P25 DES OFB
- OTAR Options - Conventional

**P25 Trunked Operation with DES Encryption**

- P25 Options - Digital Conventional
- Encryption Options - P25 DES OFB
- Trunking Options - P25 Trunking

**SMARTNET Analog and Digital Operation with Encryption**

- P25 Options - Digital SMARTNET/SmartZone
- Encryption Options - DES Securenet and DES-OFB
- Trunking Options - SMARTNET Trunking

*NOTE: The “Feature Disable Options” are currently not used, so those features are always available.*

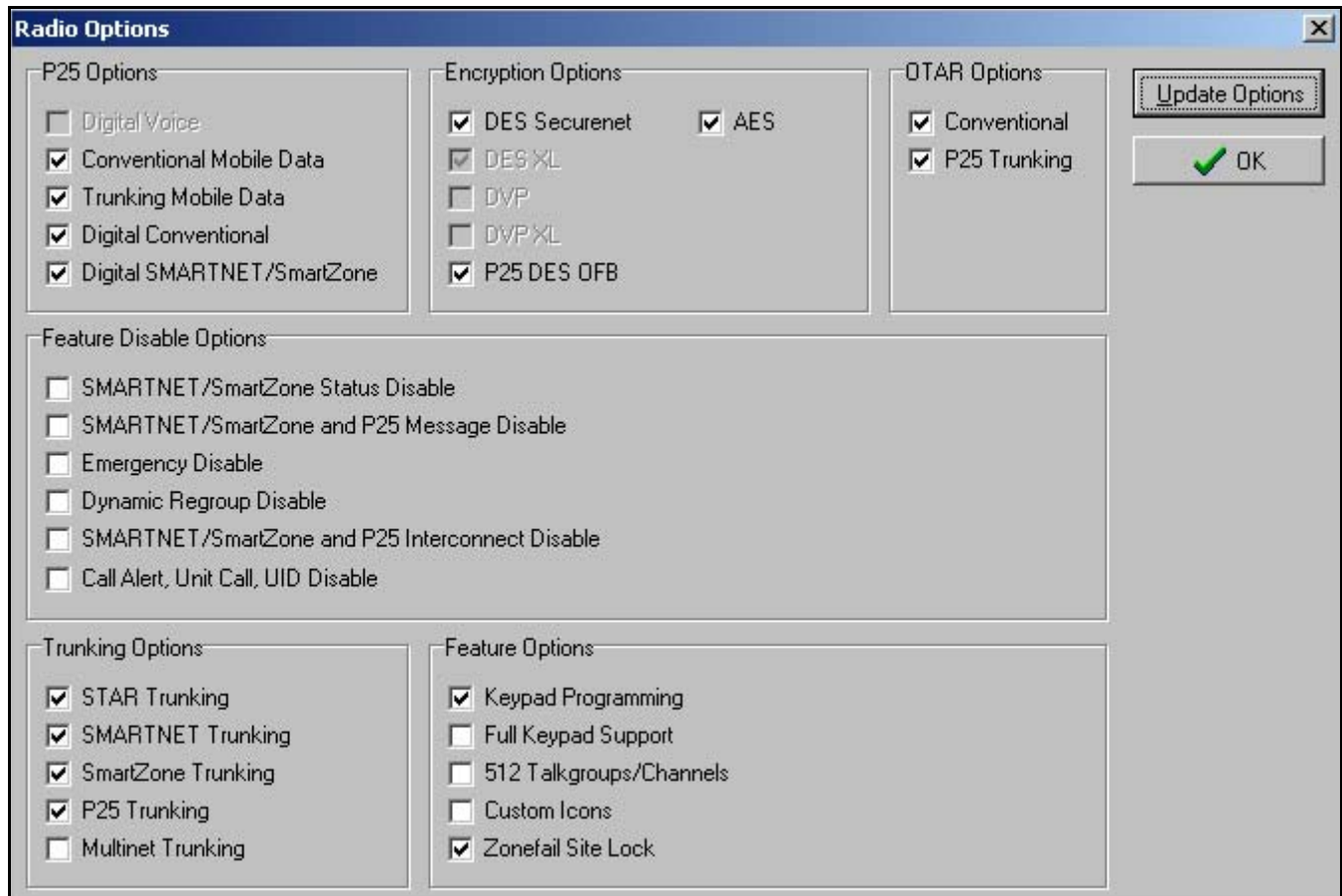

**Figure 8-1 PCConfigure Radio Options Screen**



## SECTION 9 5300 MOBILE FIRMWARE VERSIONS

### 9.1 GENERAL

There currently is, or soon will be, four different firmware versions in use in 53xx radios. Firmware is the Application code which controls the operation of the radio. It is not the standard personality information programmed by the PCConfigure programming software.

Later firmware versions may provide some operating features that are not available in earlier versions. For example, radios with Version 4.x radios may have features that are not available with Version 2.x or 3.x radios. These differences are noted in this manual in the feature description in most cases. More information on the various versions follows.

### 9.2 53XX RADIO FIRMWARE VERSIONS

#### 9.2.1 VERSION 1 (ARM) RADIOS

Earlier version 53xx radios have an ARM processor based logic board, Part No. 035-1800-4xx, which uses Version 1.x firmware. This board has a jack for plugging in Motorola UCM encryption modules that provide DES/DES-XL/DES-OFB and AES encryption. This is a different module than that used in SEM and UCM versions which follow. Two Application code files are used to program these radios. One programs DSP parameters and the other programs ARM processor parameters. This radio version has been replaced by the following versions.

#### 9.2.2 VERSION 2 AND 3 (PPC) RADIOS

Beginning in November 2003, a revised logic board began shipping. This board utilizes a PPC (Power PC<sup>®</sup>) control logic design similar to that used in the 51xx portable. This board is available in the following configurations. All versions are FIPS approved. A single Application code file is used to program these radios similar to the 51xx portable.

**SEM Version** - This version uses Version 2.x firmware and has the EFJohnson SEM (Security Encryption Module) soldered to the board. It is used whenever DES, DES-OFB, or AES encryption is required. It does not provide DES-XL encryption.

**UCM Version** - This version uses Version 3.x firmware and includes a plug-in Motorola UCM encryption module. It is used whenever DES-XL Motorola proprietary encryption is required. It also provides DES, DES-OFB, or AES encryption.

If encryption is not required, either the earlier logic board (see following) or the UCM version without the UCM module is used.

#### 9.2.3 VERSION 4 (PPC) RADIOS

A new version of the preceding SEM logic board will begin shipping in early 2005 that is redesigned to interface with a new RF board being used in these radios. The part number of this logic board is 023-5500-6xx, and it uses Version 4.x firmware. A UCM version of this board is not currently planned.

### 9.3 DETERMINING RADIO VERSION

The radio/logic board version can be determined by noting the second version number that is briefly displayed when radio power is turned on. The first number indicates the control unit code version.

### 9.4 PROGRAMMING SOFTWARE REQUIRED

Version 2.x and 3.x radios require PCConfigure programming software, Version 1.21.2.5 or later. Version 4.x radios require Version 1.25 or later. This software can also be used to program Version 1.x radios. The "5300" Radio Series is selected for both boards. The software automatically detects which board is used when parameters are written to the radio.

## SECTION 10 PASSWORD DESCRIPTION

### 10.1 NEW PASSWORD ENHANCEMENTS

#### 10.1.1 INTRODUCTION

A new enhanced password feature is now available for 5100 portables and 5300 mobiles. The number of passwords have been increased along with the number of functions that can be under password control. The single Power-On password has been replaced by the following passwords:

- **Four Power-On (User x) Passwords**
- **Download and Upload Passwords**
- **Master Password**

#### 10.1.2 SOFTWARE VERSIONS REQUIRED

The following revised PCConfigure and radio software is required for these new enhanced password features:

**PCConfigure** - Version 1.21.8 or later

##### **5100 Portable**

Version 1.x Models - 1.11.13 or later

Version 2.x Models - 2.0.4 or later

Version 3.x Models - 3.1.5 or later

##### **5300 Mobile**

Version 1.x Models - 1.23.13 or later ARM

Version 2.x Models - 2.1.10 or later

Version 3.x Models - 3.0.10 or later

*NOTE: Refer to Section 9 for more information on the preceding radio firmware versions.*

#### 10.1.3 AVAILABILITY WITH EARLIER VERSIONS

The Power-On password feature available with earlier versions of radio firmware is no longer programmable using the latest versions of PCConfigure (1.21.2.8 or later). To program that feature in

earlier radio models, an earlier version of the PCConfigure software must be used. It is programmed using the “Password at Power Up” function on the Global screen.

Otherwise, PCConfigure 1.21.2.8 or later can be used to program earlier radio models with the limitation that any new features which require updated firmware are not available.

### 10.2 PROGRAMMING PASSWORDS

#### 10.2.1 GENERAL

With new versions of PCConfigure, the “Password at Power Up” parameter has been removed from the Global screen as just described. Passwords are now programmed using a password management screen displayed by the Tools > Password Management menu. The applicable radio must be connected to the computer and powered up to display this screen.

Password data is transferred and stored in an encrypted format for security purposes. In addition, actual passwords are never displayed. They are always indicated by eight asterisks (\*\*\*\*\*). Therefore, it is not possible to determine what passwords are in a radio using the PCConfigure software.

Passwords must be 1-8 characters in length and consist of the numbers 0-9. Zeros are valid characters in any location, even as leading characters. Initially, all passwords are null (deleted) characters. Therefore, when initially programming a password, no entry is required in the “Original/Master Password” box.

#### 10.2.2 LOST PASSWORDS

If a password is lost, it can be changed using PCConfigure by entering the Master password (see following). If even the Master password is lost or was not used, all passwords can be erased using the PCTune software as follows:

1. With PCTune 1.1.1.0 or later, simply select Radio > Reset Passwords. Only password information is erased.

2. With earlier versions of PCTune, after starting the PCTune program, press SHIFT CTRL E to toggle the following Erase EEPROM function (otherwise it is grayed and not selectable). Then Select Radio > Erase EEPROM > Params Only. All password and personality information is erased, so the radio must be reprogrammed. **NOTE: DO NOT SELECT “COMPLETE” because that erases all information and the radio must then be sent back to the factory to make it usable again.**

### 10.2.3 CHANGING PASSWORDS

An assigned password can be changed by the user if the PW CHG option switch or menu parameter (5100 only) is programmed. Selecting this function displays prompts for entering and confirming a new password.

*NOTE: With the 5100 portable and 5300 Handheld Control Unit, it is recommended that a number key not be used for this function because the password mode is exited if that key is pressed to enter a number.*

### 10.2.4 PASSWORD ENTRY PROCEDURE

Whenever a password is requested, it is entered as follows:

5300 Mobile - Rotate and press the Select switch.

5100 Portable - With DTMF keypad models, enter each number using the keypad and press the F2 (Enter) key after the last digit is entered. With limited keypad models, enter each number by pressing the Up/Down switch and press the F2 key after each digit.

## 10.3 PASSWORD DESCRIPTION

### 10.3.1 USER (POWER-ON) PASSWORDS

When a User Password is enabled, it must be entered each time radio power is turned on. Up to four different User Passwords (User 1/User 2/User 3/User 4) can be programmed. Currently, the same radio features are enabled for each. Entering any User Password at power up enables normal radio operation.

### 10.3.2 DOWNLOAD/UPLOAD PASSWORDS

Separate Download (write) and Upload (read) passwords can be programmed to prevent unauthorized downloading or uploading of radio programming parameters. When one or both of these passwords are used, the proper password must be entered to perform the operation. A “User” password is not required to upload or download parameters.

### 10.3.3 MASTER PASSWORD

The Master Password overrides all the preceding passwords. It can be used by a system administrator as a “pass key” to a password controlled function or to change a lost or inadvertently changed password. Master passwords are set up and changed the same as the other passwords. It does not override the following Zone Password.

## 10.4 ZONE PASSWORD

*NOTE: The programming and usage of this password has not changed. It is independent from the preceding passwords, and programmed in the Zone > Edit Zones and Channels screen.*

A zone password can also be programmed with the 5300 mobile and 5100 portable. It prevents unauthorized reprogramming of zones by keypad programming. When this password is used, it must be entered before system or channel parameters in that zone can be changed. The zone password is programmed in the Edit Zones and Channels screen. This screen is displayed by clicking the Edit Zone button on the Zone screen.

A different password can be programmed for each zone. When a password protected zone is selected, “PASSWORD” is flashed the first time an attempt is made to select a system or channel parameter in that zone. Each digit of the password is then entered as previously described. The password is always eight digits long, and after the eighth digit is entered, system and channel parameters for that zone can be reprogrammed normally.

## SECTION 11 SECURE COMMUNICATION (ENCRYPTION)

### 11.1 GENERAL

#### 11.1.1 INTRODUCTION

This radio may be equipped to provide secure communication on some or all channels. This feature encrypts the voice so that it can be understood only by someone using a radio equipped with a similar encryption device and encryption codes.

When a secure call is received or transmitted,  is indicated in the display (see Section 11.2.7). If equipped with the Clear/Secure option switch and the current channel is programmed to allow switch selection, secure communication can be manually enabled and disabled by that switch. Otherwise, channels are strapped to Clear or Coded operation (see Section 11.3). Secure communication can be programmed on a per channel or per talk group basis to operate in various ways. More information follows.

#### 11.1.2 ENCRYPTION ALGORITHMS

##### SecureNet™

SecureNet encryption digitizes the voice and then encrypts it using the DES or DVP algorithm. It uses a 64-bit encryption key. The SecureNet protocols include the following algorithms:

- DVP (Digital Voice Privacy) is an earlier encryption method that is self synchronizing using cipher feedback. It was originally designed to be used by anyone needing protection from unauthorized eavesdropping.
- DES (Data Encryption Standard) provides a higher level of security, and also uses cipher feedback. It was originally designed to be used only by the Federal government.
- DVP-XL/DES-XL - A disadvantage of the DVP and DES encryption types is reduced communication range when compared to clear voice. The DES-XL and DVP-XL methods were designed to provide better range but at the cost of lower voice quality.

They use a different type of feedback called counter addressing.

- DES-OFB - A form of DES encryption for digital channels that uses output feedback. This protocol does not result in the degraded range that occurs with analog channels.

##### AES (Advanced Encryption Standard)

A new encryption standard called AES is replacing DES-OFB encryption on digital (P25) channels. It uses a 128-, 192-, or 256-bit encryption key instead of the 64-bit key used with DES. EFJohnson radios currently support only 256-bit AES keys. The type of encryption (DES or AES) is determined by the type of encryption key that is loaded (see Section 11.2), and not by the PCConfigure programming software. AES encryption, like DES encryption, is an optional radio feature that must be purchased and then enabled at the factory.

#### 11.1.3 ENCRYPTION AVAILABLE WITH VARIOUS CHANNEL TYPES

##### Analog Channels

On analog conventional and SMARTNET/Smart-Zone channels, DES and DES-XL encryption is used to provide secure communication. The DES-XL type is available only with 5300 mobiles equipped with the Motorola UCM (Universal Crypto Module). Refer to the next section for more information.

##### Digital Channels

On digital Project 25 and SMARTNET/Smart-Zone channels, the DES-OFB or AES protocol is used (AES is available with ARM code 1.20.0 or later and all 2.0/3.0). Refer to Section 11.1.4 for more information.

#### 11.1.4 5300 ENCRYPTION CAPABILITIES

As described in Section 9, there are now three different 5300 versions which provide various encryption capabilities.

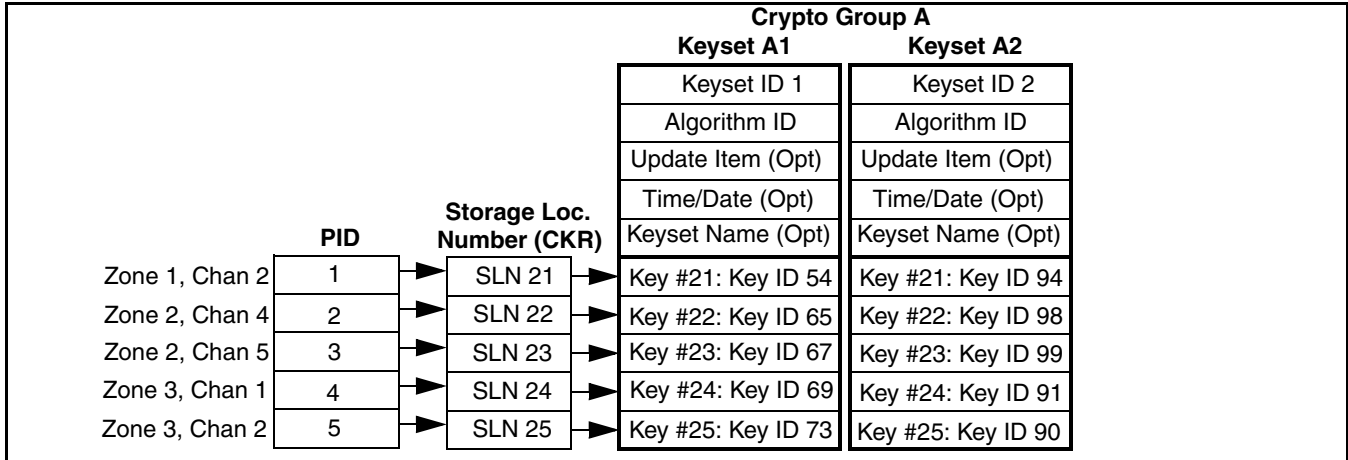

Figure 11-1 Key Selection Example

11.1.5 FIPS AND NON-FIPS MODES

FIPS 140-2 is a Federal Information Processing Standard for encrypted radios used by the Federal Government. This standard specifies Federal security requirements for cryptographic modules for a wide range of applications and environments. All 5300 models are FIPS certified.

11.2 ENCRYPTION KEYS

11.2.1 INTRODUCTION

An encryption key is a cryptographic variable that is required by the encryption algorithm to encrypt and decrypt voice or data. To maintain system security, these keys must be protected from disclosure and also periodically replaced or updated.

With the AES and DES encryption used by EFJohnson radios (see Section 11.1.2), the same encryption key is used by both the encrypting (sending) and decrypting (receiving) radio. AES encryption keys are generated from a string of 64 hexadecimal characters, and DES keys are generated from a string of 16 hexadecimal characters. Another four hexadecimal characters are used to specify the key ID. Multiple keys can be loaded into a radio using OTAR or manual loading.

When an encrypted message is transmitted, the encryption Algorithm ID (ALID) and key ID (KID) are usually included in the message. This tells the

receiving radio which key and algorithm must be used to decrypt the message.

If an attempt is made to transmit a secure message without loading the corresponding key, “KEYFAIL” is displayed. The message must then be transmitted in the clear mode (this is possible only if the channel is strapped to “switchable”) or the key must be loaded.

11.2.2 KEY AND ALGORITHM IDS

Each encryption key is programmed with a Key ID (also called Logical ID). This ID plus the algorithm ID (ALGID) is transmitted in the message. The radio receiving the message must have a key programmed with the same IDs in order to decrypt it.

11.2.3 PID/SLN KEY MANAGEMENT MODES

NOTE: The term “SLN” from the Project 25 specification is equivalent to “CKR” (Common Key Reference) also used to define this parameter.

The channels, talk groups, and other calls that use encryption are linked to a specific Physical ID (PID) when the radio is programmed using the PCConfigure programming software. For example, Zone 1, channel 1 could be programmed to select the key in PID 1 and Zone 1, channel 2 could select the key in PID 3. The PID ranges are 0-15 when the PID mode is selected,

and 1-16 when the SLN mode is selected (see Figure 11-1).

PID or SLN key management modes can be programmed on the Global programming screen. More information on these modes follows.

**PID Mode** - The PID mode can be used only when keys are loaded using the Motorola KVL 3000 keyloader. When this mode is selected, keys are loaded directly into a PID of 0-15 that corresponds to the PID programmed for each channel (if applicable). A Keys Table is not programmed with this mode.

**SLN Mode** - The SLN mode must be selected is either OTAR (Over-The-Air-Rekeying) or the EFJohnson System Management Assistant (PDA keyloader) is used. It can also be used if OTAR is not used. With this mode, keys are loaded into a SLN (Storage Location Number), typically from 0-4095. A Keys Table must then be programmed to link channel PIDs to a specific SLN.

The use of this type of indirect linking allows keysets and key IDs to be changed via OTAR while keeping the mapping from the channel or talk group the same. For example, as shown in Figure 11-1, PID 4 selects SLN 24 which selects key slot 24 in both keysets. This slot contains Key ID 69 in Keyset 1 and Key ID 91 in Keyset 2. Only one keyset is active at a time.

#### 11.2.4 MAINTAINING KEYS IN MEMORY

The radio may need to be connected to a constant power source to preserve the encryption keys in memory. The programming of the Infinite Key Retention parameter determines if keys are permanently stored in memory or erased soon after power is removed. This parameter is available in 5100 models with firmware 1.11.0/2.0/3.0 or later.

When Infinite Key Retention is enabled, keys are stored in memory and are not lost when power is removed. If it is disabled, they are maintained only until the storage capacitance discharges. With 5100 portable models, storage capacitors maintain the supply voltage (and encryption keys) for approximately 30 seconds without power applied. Therefore, when changing the battery, make sure to reattach another within 30 seconds.

With 5300 mobile models, the keys are maintained for approximately 8 hours with this feature disabled. However, a tamper switch causes immediate key erasure when the radio cover over the logic board is removed.

#### 11.2.5 ENCRYPTION KEY SELECT

NOTE: This feature is available on conventional channels only.

When multiple encryption keys are programmed (see preceding information), the KY SEL option switch can be programmed to allow selection of another key for the current channel. This feature changes the PID (hardware location) of the key, and the change is permanent (cycling power or selecting a different channel does not reselect the original key). Therefore, to switch back to the original key, it must be manually reselected. Proceed as follows to select a key:

1. Press the KY SEL option switch and HWKEY x is displayed. The “x” indicates the current key PID selection.
2. Rotate the Select switch to display the desired key and then press the Select switch to select it. Press the KY SEL option switch again to return the display to normal operation.

#### 11.2.6 ENCRYPTION KEY ERASE

A KY CLR option switch can be programmed that allows the user to permanently erase all stored keys. If OTAR TEK and KEK keys are stored, all keys of both types are erased. This function can be used to ensure that unauthorized encrypted calls can no longer be placed or received by a radio.

#### 11.2.7 ENCRYPTION ICON OPERATION

Basically, the encryption icon  is on continuously whenever a secure call is received or transmitted. Other operation is as follows:

- It flashes when receiving a secure call in either the secure or clear mode on a digital channel.
- It is on continuously when receiving a clear call in the secure mode on a digital channel.

- There is a programmable option on the Radio Wide screen to sound a beep whenever a secure call is received on a clear channel.

## 11.3 CLEAR/SECURE STRAPPING

### 11.3.1 TRANSMIT MODE OPTIONS

The following transmit options are available when encryption is selected:

**Clear** - All calls are in the clear mode unless responding to a secure call. If the response is then made within the delay time (see Section 4.11.4), it occurs in the secure mode.

**Secure** - All calls are made in the selected secure mode.

**Switched** - The mode is selected by the C/S (Clear/Secure) option switch. When the clear mode is selected by this switch, “CLEAR” is flashed, and when the secure mode is selected, “SECURE” is flashed.

If the channel has been strapped “Clear” and the option switch selects the “Secure” mode on power up and a transmission is attempted, “Clear Only” is displayed and transmitting is disabled. Likewise, if the channel is strapped “Secure” and the option switch selects the “Clear” mode on power up and a transmission is attempted, “Secure Only” is displayed and the transmitter is disabled.

The radio can be programmed to ignore the “Clear” or “Secure” switch setting (“Ignore Clear/Secure Switch When Strapped” selected on Global screen). These preceding indications then do not occur and transmissions always occur in the strapped mode.

*NOTE: If all channels/talk groups are strapped clear or secure and no C/S (Clear/Secure) option switch is programmed, this parameter must always be selected (see following).*

If the C/S (Clear/Secure) switch is not programmed, the radio is always in the last known state (usually Clear) and there is no way to change it. For example, if the last known state is Clear and this parameter is not selected, it is never possible to

transmit a Secure message on a channel strapped Secure because all that happens is transmitting is disabled, an error tone sounds, and “Sec Only” is displayed.

### 11.3.2 RECEIVE MODE OPTIONS

The following receive options can be programmed with conventional operation. With SMARTNET/SmartZone and P25 Trunked operation, encrypted calls are received if the proper key is programmed.

**No Autodetect** - Only signals coded like the transmit signals are received.

**Secure Autodetect** - Both clear and secure signals are automatically detected. This mode is automatically selected if the transmit mode is switch selectable.

#### Proper Key Autodetect

##### Analog Channels

When this feature is disabled and a message is received with the wrong key, the audio unmutes and garbled (encrypted) audio is heard. However, if this occurs with this feature enabled, the audio remains muted.

##### Digital Channels

When this feature is enabled and a message is received with a different key, but the key resides in the radio, the audio is decrypted and received normally even though the key is assigned to a different talk group. If this feature is disabled or the key does not reside in the radio, the audio remains muted.

### 11.3.3 TALK GROUP ENCRYPTION OVERRIDE

On conventional digital (P25) channels, the encryption strapping mode and PID are programmed on a per talk group basis similar to the trunked modes (SMARTNET/SmartZone/P25 Trunked). However, with this mode only, there is the option to override the talk group encryption programming and program it on a per channel basis. Therefore, if desired on conventional digital channels, encryption can be programmed

differently for each channel. Conventional analog channel encryption is always programmed on a per channel basis.

## 11.4 OTAR (OVER-THE-AIR REKEYING)

### 11.4.1 INTRODUCTION

OTAR stands for “Over-The Air-Rekeying”. This is the process of sending encryption keys and related key management messages over-the-air to specific radios. The advantage of OTAR is that it allows these keys to be quickly and conveniently updated when necessary. It is no longer necessary to periodically travel to the radio location or bring the radio into a maintenance facility to load new keys.

The actual OTAR rekeying functions are performed by a Key Management Facility (KMF) that sends Key Management Messages (KMM) to the radios. These messages are themselves encrypted using a unique key. Radios must be OTAR-compatible and programmed for OTAR for this type of rekeying to occur.

OTAR is available only on P25 conventional and trunked channels, and only to program DES-OFB and AES keys. It is not used on SMARTNET/SmartZone channels or to load DES/DES-XL keys.

### 11.4.2 ENCRYPTION KEY TYPES

There are two types of keys used with OTAR:

**TEK (Traffic Encryption Key)** - The key used to encrypt voice and data traffic. All radios using encryption must have at least one of these keys. This is also another name for the keys used without OTAR.

**KEK (Key Encryption Key)** - The key used to encrypt keys contained in OTAR Key Management Messages (KMMs). All radios which use OTAR must contain at least one of these keys. The KEK used to decrypt/encrypt keys in an OTAR message is defined by the algorithm and key IDs transmitted in the decryption instructions field. A KEK may be unique to a particular radio (UKEK) or common to a group of radios (CKEK).

### 11.4.3 KEYSSETS

To simplify key management, a number of keys may be grouped together in a keyset. A keyset is simply a set of one or more keys of the same type (either TEK or KEK). Keysets are identified by Keyset IDs, and the upper four bits of this ID specify the crypto group (see next section).

The KEK keyset is considered always active and is ID 255. Two TEK keysets are normally used, and one is always active and the other inactive. This allows the inactive keyset to be replaced without interrupting operation. One is Keyset ID 1 and the other Keyset ID 2. With EFJohnson radios, each keyset can contain up to 128 keys, but less than 16 are normally used for optimum keying efficiency and because only up to 16 can be selected by the radio.

The active keyset is usually selected by the Key Management Facility. It can also be selected by the EFJohnson SMA keyloader or by the user if the KY CHG option switch is programmed. Automatic keyset changeovers are not supported by EFJohnson radios. In the SLN mode (see Section 11.2.3), two TEK keysets can be used if desired even if OTAR is not used.

A diagram of a keyset is shown in Figure 11-2. Some information may be optional as shown. The 5300 mobile does not support or use the Update Item and Time/Date parameters.

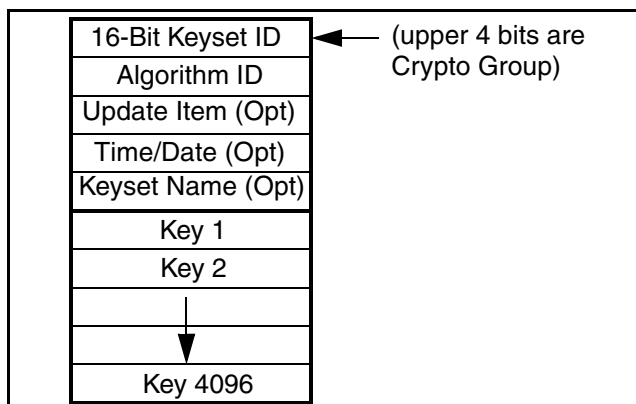

Figure 11-2 Keyset Diagram

### 11.4.4 CRYPTO GROUPS

A crypto group contains up to 16 keysets of the same type of key, either TEK or KEK (see Section



11.4.2). However, only two keysets are typically used as just described. Crypto groups are used to help manage keys such as when a radio uses keys with different active times or multiple algorithms. Currently, only one crypto group is supported, and it is always ID 0. As shown in Figure 11-3, the crypto group ID is the upper four bits of both the SLN and Keypad IDs.

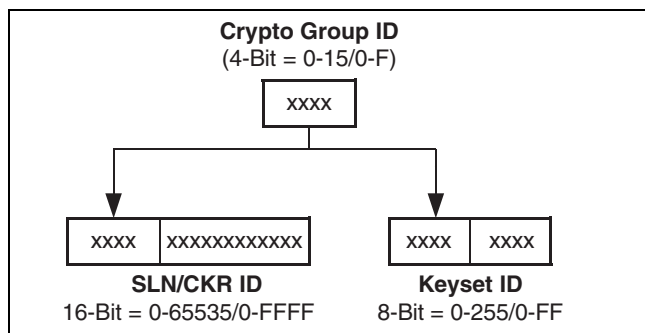

Figure 11-3 Encryption Parameter IDs

11.4.5 KEY MANAGEMENT FACILITY

The Key Management Facility (KMF) provides key management and OTAR functions to applicable radios within the radio system. One of the main tasks of the KMF is to maintain a data base of information contained in each radio. This information may include the following:

- TEKs (main Traffic Encryption Keys)
- KEKs (Key Encryption Keys) used to encrypt OTAR messages
- Keysets (groups of TEKs or KEKs)
- Crypto groups (groups of keysets)
- Cryptonets (groups of radios using same keys)
- Individual and group Radio Set Identifiers (RSIs)
- List of probable lost or stolen radios

The KMF performs OTAR functions by exchanging Key Management Messages (KMMs) with the radios. Both the KMF and radio can originate messages. Some functions performed by the KMF are as follows:

- Loading new keys
- Modifying keys
- Initiating keypad switch overs
- Modifying keypad attributes
- Deleting one or more keys to remove a radio from a cryptonet)

- Deleting all keys (zeroize) when a radio may be lost or compromised
- Determining if a radio is on the air and reading key information
- Changing individual and group RSIs

11.4.6 MESSAGE NUMBER PERIOD (MNP)

One of the parameters that is programmed in a radio utilizing OTAR is Message Number Period (MNP). This parameter is programmed as described in Section 11.5.2. This parameter is used to minimize the possibility of someone sending messages to “spoof” the system. The MNP is used as follows.

Every message sent out has a message number. The message number increments by one with each message sent. The MNP is the maximum difference allowed between messages. For example, if the MNP is set to 1000 and the last message number received by the radio is different by more than 1000 from the current message number, the current message is ignored. If the MNP is set to 65535, message numbers are ignored.

When determining this number, consider the likelihood of someone trying to spoof the system by retransmitting recorded messages and then adjust the MNP accordingly. The higher the risk, the smaller the MNP should be. A disadvantage of setting a low MNP is that the chance of blocking out intended messages becomes higher. In addition, traffic level and terrain contribute to lost messages and should also be considered when selecting this number.

A setting of 1000 is a good compromise because it blocks out real old messages but is unlikely to affect anything intentionally sent out by the system (1000 messages sent to a single radio is not likely to occur in a system in less than a year with normal usage).

11.4.7 DEFINITIONS

**Algorithm** - Refers to the specific encryption standard (DES or AES) that is used to encrypt a message. Each standard uses different calculations to perform the encryption (see Section 11.1.2).

**Algorithm ID (ALGID)** - Identifies the algorithm (DES or AES) used to encrypt a message. This ID and

the Key ID are transmitted with each message to uniquely identify the key being used.

**Black** - Refers to information that is encrypted. The opposite is “Red” which refers to unencrypted information.

**Common Key Encryption Key (CKEK)** - This is a KEK common to a group of subscriber units which share the same encryption keys (are part of same crypto group). These keys can be the DES or AES type. The use of a common key allows the subscriber units to be rekeyed by the KMF using one Key Management Message. Refer to “KEK” for more information.

**Common Key Reference (CKR) Group** - Same as Storage Location Number (SLN).

**Crypto Group** - A group of up to 16 keysets containing the same type of keys (either TEK or KEK). Although a crypto group can contain up to 16 keysets, only two are normally used. Only one keyset in a crypto group is active at a time. EFJohnson radios currently support only one crypto group.

**Cryptographic Variable** - The variable used by a cryptographic algorithm to encrypt a message. Also called a “key”.

**Currency** - Relates to the need for key updates. If a subscriber unit is current, it does not require a key update at the current time. If it is not current, the KMF has new keys for that subscriber unit or CKR group have not been sent or have been sent but not acknowledged.

**Group Rekeying** - The process of changing the keys in several subscriber units with a single message addressed to the group rather than changing each subscriber unit separately. This addressing is done using a group RSI. Group rekeying reduces system overhead and makes rekeying more efficient. Subscriber units in the same group must be programmed with a common KEK (CKEK) and use the same TEKs.

**Key** - A variable used by a cryptographic algorithm to encrypt voice or data. Also called “Cryptographic Variable”.

**Key Encryption Key (KEK)** - A key used to encrypt keys contained in Key Management Messages (KMMs) during OTAR. These messages may themselves be encrypted by the currently active TEK. These keys can be the AES or DES type. There are KEKs unique to a subscriber unit (UKEK) and common to a group (CKEK). The other type of key is the Traffic Encryption Key (TEK) used to encrypt voice and data messages.

**Key ID** - This is a 16-bit (four hex digit) number identifier from 1-65535 for an encryption key which allows the key to be identified without revealing the actual key variable. This ID and the Algorithm ID uniquely identify a key within the KMF or subscriber unit. Therefore, two keys can have the same ID if they have different algorithm IDs and vice versa. The Key ID and Algorithm ID are usually transmitted with a message to identify the key that must be used to decrypt it. Key ID 0 is not used with OTAR.

**Key Management Facility (KMF)** - The equipment and software which provide OTAR and related key management services to the subscriber units.

**Key Management Message (KMM)** - These are the messages composed by the KMF to send encryption information to subscriber units via the keyloader or OTAR. KMMs are themselves encrypted using two layers of encryption: inner and outer. The inner layer of encryption is the KEK and the outer layer is the TEK. At this layer, the KMMs are also included in a Common Air Interface (CAI) message which adds another layer of addressing. In addition, a Message Authentication Code (MAC) is used.

**Keyset** - A group of keys of the same type (KEK or TEK) that are managed as a single entity (they can be updated, deleted, and rekeyed with a single command).

**Keyset Changeover** - The process used to switch a subscriber unit to another keyset so that the unused keyset can be replaced without interrupting encrypted communication.

**Key Loader** - Any type of device used to load encryption keys into a radio. With OTAR, this device must be used to provide the initial key loading of a subscriber unit so that it contains the basic keys needed for

OTAR by the KMF. If OTAR is not utilized, is always used to load encryption keys. All keys stored in the key loader are themselves encrypted. EFJohnson offers a PDA-based keyloader.

**Logical Link ID (LLID)** - An ID transmitted with a data message to identify the destination of the message.

**Message Number Period (MNP)** - The maximum difference between message numbers that can occur before a message is declared invalid (see Section 11.4.6).

**Over-The-Air-Rekeying (OTAR)** - The process of sending new encryption keys over the air using an RF interface.

**Red** - Refers to information that is not encrypted. The opposite is “Black”.

**Rekey** - The process of preparing, sending, and loading encryption keys into a subscriber unit for current or future use. This may be done over-the-air (OTAR) or by directly connecting a keyloader to the subscriber unit.

**Radio Set Identifier (RSI)** - Subscriber units are programmed with one or more Radio Set Identifier (RSI) numbers that identify the unit for OTAR purposes. The RSI can be unique to a individual subscriber unit or unique to a group of subscriber units. An individual (unit) RSI is always assigned and one or more group RSIs may be assigned. The individual RSI is typically programmed when the subscriber unit is initially brought into service. The KMF is also identified by an RSI (KMFRSI) to use as the destination of any KMMs a subscriber unit originates. The KMMs (Key Management Messages) generated by the KMF (Key Management Facility) are addressed to a specific RSI.

**Storage Location Number (SLN)** - A link to a specific key (TEK or KEK) in the active keyset. The SLN specifies both a crypto group and a key within the keysets in that crypto group (the first four bits of the SLN are the crypto group ID). SLNs and CKRs are equivalent terms (see Section 11.2).

**Traffic Encryption Key (TEK)** - A key used to encrypt voice or data. The other type of key is the Key

Encryption Key (KEK) which is used to encrypt keys contained in Key Management Messages. TEKs can be either the AES or DES type.

**Unique Key Encryption Key (UKEK)** - A KEK unique to a particular subscriber unit. Refer to “KEK” for more information. These keys can be either the AES or DES type.

**Zeroize** - The process of deleting all keys from a compromised subscriber unit to disable it. To make the unit functional again, the keys must be reloaded by a keyloader.

## 11.5 RADIO SETUP FOR ENCRYPTION

### 11.5.1 GENERAL ENCRYPTION SETUP

The following radio setup is required for encryption regardless of whether OTAR is used:

**Options Enabled** - The desired encryption type must have been enabled at the factory (DES, DES-XL, DES-OFB, AES). To determine what options are enabled, using the PCConfigure programming software, select the Transfer > Read Options From Radio menu parameter.

#### PCConfigure Programming

PID/SLN Mode - On the global screen (Page 2) select either the PID or SLN mode (see Section 11.2.3). If the SLN mode is used, also program the Keys Table by clicking the  button.

Infinite Key Retention - On the global screen, select this parameter to store keys permanently in memory (see Section 11.2.4).

Erase Keys On Keyset Change - On the global screen, if the SLN mode is selected and more than one keyset is used (see Section 11.4.3), select this parameter to erase keys when changing keysets (see Section 11.2.6).

Program Channel/Group PIDs and Encryption Type - With conventional analog calls, this information is programmed on the channel screen. With other types, it is programmed in the talk group list selected on the system screen. In addi-

tion, with conventional digital calls, the group programming can be overridden on the channel screen (see Section 11.3.3). Additional PIDs for special calls can also be specified on the system screen for digital and trunked calls. *NOTE: The encryption type is not selectable on digital channels because the AES/DES mode is determined by the key type loaded, not by PCConfigure programming.*

Currently, EFJohnson 5100 portables and 5300 mobiles that meet the following requirements support OTAR:

**Software Version Number** - The 5100 must have firmware (operating software) version number 1.5.0/2.0/3.0 or higher, and the 5300 must have firmware 2.0/3.0 or higher or ARM code 1.16.0 or higher and DSP code 1.32.0 or higher. The software version number is briefly displayed when power is turned on. It can also be determined using the PCConfigure programming software by selecting the Transfer > Read Version Info from Radio menu parameter.

**Programming** - An RSI and UKEK and other information must be programmed as described in the next section.

## 11.5.2 ADDITIONAL SETUP FOR OTAR

### Additional PCConfigure Programming For OTAR

The following parameters must be programmed for OTAR operation in addition to those in Section 11.5.1 (PCConfigure Version 1.17 or later is required). The following describes programming with Version 1.25 or later.

1. On the Radio Wide Conventional screen, program the Digital Unit ID.
2. On the Global screen, Page 2, set the Unit RSI ID as desired (normally this ID is initially the same as the Digital Unit ID). It can be changed later by the KMF or keyloader if desired. Note these two IDs.
3. On the Per System Conventional screen, Page 2, for OTAR and Data Settings, select OTAR Enabled = On and Data Registration Enabled = On. When data registration is enabled, the radio registers with the data system on a channel change.

4. Also on this screen, set the other OTAR and Data parameters. The OTAR Rekey Request Time Out determines how long the radio waits for a response from the KMF. Times of 20-180 seconds can be programmed, and the default is 30 seconds. Refer to the PCConfigure software manual and Help for more information on these parameters.

### Motorola RNC Registration (If Required)

The 5100/5300 may not support Motorola dynamic data registration. Therefore, each radio may need to be manually registered on the Motorola RNC Console by entering the following command:

**LCRD 03 06 00 1234 7F xx xx xx 0A 0A 00 07 00 yy**

Where, “xx xx xx” is the hex value of the Digital Unit ID entered by the PCConfigure software. Refer to the console documentation for the value of “yy” or use “00”. This registration needs to be done only once.

### Programming By Keyloader

The following are the minimum parameters that need to be programmed in the radio to perform OTAR. It is not necessary to program a TEK to perform OTAR. If the radio does not contain a TEK, the KMF initiates a warm start-up sequence in which a temporary TEK is transferred to the radio to perform the key transfer.

1. **UKEK** - This key normally has SLN (CKR) 61440 and Key ID 62880 (F5A0 hex). Create a key (either AES or DES type as required) and download it to the radio.
2. **Unit RSI** - This is normally initially the same as the P25 Unit ID and is programmed by the PCConfigure software as described in Section 11.5.1. Therefore, the RSI should not need to be loaded if it is the first time the radio is being set up for OTAR or if the radio dumps keys due to long-term battery disconnect. However, it may need to be loaded if the radio is manually deleted from the KMF and then recreated since the message number must be reset to 0 (the Load Target RSI command resets the message number to 0).

3. **KMF RSI** - This RSI is normally 9,999,999 and should not need to be loaded since it defaults to this number.
4. **MNP (Message Number Period)** - Load the proper message number period into the radio (typically 1000). Refer to Section 11.4.6 for more information.
5. Verify that the above information was properly stored in the radio by viewing it using the keyloader.

KEYSET CHANGEOVER	0x05
KEYSET CHANGEOVER RESPONSE	0x06
DELAYED ACK	0x07
HELLO	0x0C
INVENTORY	0x0D
INVENTORY RESPONSE	0x0E
MODIFY KEY	0x13
MODIFY KEYSET ATTRIBUTES	0x14
MODIFY KEYSET ATTRIBUTES RESPONSE	0x15
NEGATIVE ACK	0x16
NO SERVICE	0x17
REKEY ACK	0x1D
REKEY	0x1E
WARM START	0x20
ZEROIZE	0x21
ZEROIZE RESPONSE	0x22

## 11.6 RADIO OTAR CAPABILITIES

### 11.6.1 SEM 5100/5300, STANDARD 5100

The OTAR capabilities of the SEM equipped 5100 portable and 5300 mobile and also standard (Version 1.x) 5100 are as follows. Refer to Section 9 for more version information.

#### Keysets

- Up to three keysets are used and it is assumed all three are always present. Keyset IDs 1 and 2 are for TEKs and only one is active at a time. Keyset ID 255 is for KEKs and is considered active all the time
- Each keyset can have up to 128 keys. However, 16 or less are normally used.
- AES encryption is supported (with Flash code 1.8.0 or later) but not currently available with OTAR (future availability is planned).

#### RSI (Radio Set Identifier)

- One individual RSI and it is usually initially the same as the P25 Unit ID.
- One group RSI (usually initially “0”).
- One KMF RSI (usually always 9,999,999).

#### OTAR Messages That Are Supported

The following KMM Message IDs are recognized by or sent:

CHANGE RSI	0x03
CHANGE RSI RESPONSE	0x04

### 11.6.2 UCM EQUIPPED 5300

The 5300 UCM versions (see Section 9) use the Motorola UCM encryption module. Therefore, the OTAR capabilities are determined by that module. All capabilities of the Motorola KVL and KMF are supported. Initial radio programming by the PCConfigure software is the same as described in Section 11.5.

### 11.6.3 OTAR OPTION SWITCHES

The following additional option switches can be programmed with the 5100 portable and 5300 mobile to control OTAR functions. They are also available as 5100 menu parameters unless noted otherwise.

**Change Keyset** - Toggles the active keyset between Keyset 1 and Keyset 2. The new active keyset is briefly displayed and then normal operation resumes. When the 5100 menu is used, the current active keyset is indicated by an asterisk. To change to the other keyset, highlight it and press the F2 key.

**Clear/Secure Select** - This enables and disables encryption regardless of whether OTAR is used. Refer to Section 11.3 for more information.

**Erase Keys** - Erases all TEK and KEK keys contained in the radio. With the 5100, this function is available as menu parameter only.

**Key Select** - This allows a different key to be selected for the current channel or group (conventional channels only). Refer to Section 11.2.5 for more information.

**OTAR Rekey Request** - Sends a message which tells the KMF that the radio is on the air and requests rekeying. The following status messages are displayed which indicate the progress of this function. Additional functions that are available when this is selected using the 5100 menu mode are described in the next section.

Rekeying - A radio-initiated rekeying session is in process.

No Ack - No response was received from the KMF in response to an Identify request before time out occurred (approximately 30 seconds).

Ack Rcvd - An acknowledgement was received in response to an Identify request.

No Service - A “No Service” reply was received from the KMF. No rekeying will take place.

Rekey Fail - Either the rekey command failed or timed out (after approximately 30 seconds). This message could indicate that the rekey request message was not received by the KMF. However, depending on the KMF configuration and channel traffic, it is possible that the message was received and a response is still pending.

Rekeyed! - The rekey session initiated by the radio was successful.

#### **Additional Functions Selectable by 5100 Menu:**

(To select one a parameter, highlight it and press F2.)

Rekey - Performs the same function as the OTAR Rekey Request option switch described in the preceding section.

Need KEK - Sends a request for a new KEK (Key Encryption Key). Upon receiving this message, the KMF marks the radio as requiring service. One time this function may be selected is if the radio dumps it keys.

Identify - Sends a message which tells the KMF that the radio is on the air. Currently, the KMF always responds with “No Service”, even if the keys are not up to date. If “No Ack” is displayed, the KMF may not have received the message (see preceding section). This function can be used to test communication without initiating the rekeying that occurs with the preceding “Rekey” function.

Erase Keys - Erases all keys in the radio the same as the Erase Keys option switch described in the preceding section.

## INDEX

**Numerics**

5300 Versions 57

**A**

AES Encryption 60  
 Algorithm 65  
 Algorithm ID 65  
 Alias 14  
 Alphanumeric Display 11  
 Analog and Digital Operation 40  
 ANI Signaling 32  
 Autodetect 63

**B**

Backlight 14  
 Battery Discharge 54  
 Black 66  
 Busy Channel Lockout 26, 32  
 Busy Indicator 25  
 Busy Override 48

**C**

Call Alert (P25 Conv) 35  
 Call Alert (Paging) 44  
 Call Guard Squelch 26  
 CHAN PARMS 37  
 Channel 12, 14  
 Channels 17  
 CHNG CHAN 37  
 CHNG ZONE 37  
 CKEK 66  
 CKR 66  
 Clear/Secure Strapping 63  
 Connector  
   Accessory 11  
   Antenna 11  
   Data 11  
   DC Power 11  
   Remote Control Unit 11  
   Siren 11  
 Conventional Mode 16  
 Conversation Timer 27  
 Crypto Group 64, 66  
 Cryptographic Variable 66  
 Currency 66

**D**

DES-OFB 60  
 DES-XL 60  
 Determining Available Options 55  
 Determining Options 55  
 Digital Call Guard Squelch 26  
 Direct Channel Selection 14  
 Display 11  
   Zone/Channel 14

Display View Angle Adjust 14  
 Displaying Frequency 28  
 Dynamic Regrouping 48

**E**

Emergency Alarms (Conv) 28  
 Emergency Alarms (SN/SZ) 46  
 Emergency Calls 46  
 Emergency Calls (Conv) 29  
 Emergency Hot Mic 29, 46  
 Encryption 60  
 Encryption Key 61  
 Encryption Key Select 62  
 Encryption Keys 61  
 Encryption KY CLR (Key Erase) 62  
 Enh. Priv. Conversation Calls  
   Placing 41  
   Receiving 43  
 Extended Range Operation 54

**F**

Facility 65  
 Failsoft Operation 47  
 Features  
   Conventional 8  
   General 8  
   P25 Trunked 9  
   Project 25 32  
   Project 25 Trunked 9  
   SMARTNET/SmartZone 8, 40  
   SmartZone 48  
 FIPS 140-2 61

**G**

Group IDs, Project 25 32  
 Group Rekeying 66

**H**

Home Zone Select 19  
 Horn Alert 20  
 Hot Mic 29, 46

**I**

Indicator  
   Encryption 12  
   Monitor 12  
   Priority Channel 12, 31  
   Scan 12  
   Scan List 12  
   Second Priority Channel 12  
   Telephone Call 12  
 Infinite Key Retention 62

**K**

KEK 66

Key 66  
 Key Encryption Key 64  
 Key ID 61, 66  
 Key Loader 66  
 Key Management Facility 65  
 Keypad Programming 36  
 Keypad 64, 66  
 Keypad Changeover 66  
 KMF 66  
 KMF RSI 69  
 KMM 66

**L**

Licensing 54  
 Lookback Time 31  
 Lost Passwords 58

**M**

Message Number Period 67  
 Message Number Period (MNP) 65  
 Messaging 45  
 Messaging (Conv P25) 36  
 Microphone Off-Hook 20  
 MNP 69  
 Mode  
   Conventional 16  
   Project 25 Conv 16  
   Project 25 Trunked 16  
   SMARTNET/SmartZone 16  
 Monitor Mode 25  
 Monitoring Before Transmitting 25  
 Multi-function Indicator 10

**N**

NAC 33  
 Network Access Code 33  
 Nuisance Channel Delete 22

**O**

On-Off/Volume Control 10  
 Operating Modes 15  
 Option Button  
   KY SEL (Key Select) 62  
 Option Switch  
   ALERT (Call Alert) 35, 45  
   BKLHT (Backlight) 14  
   C/S (Clear/Secure) 40, 42, 69  
   CALL (Private Call) 35, 41, 42, 43, 44  
   CALL (Unit Call) 33  
   Cancel Dynamic Regrouping 48  
   Channel Select 14  
   DATA (P25 Packet Data) 36  
   DISP (Displayed Information) 28  
   EMER (Emergency) 28, 29, 46  
   HOME (Zone) 19

- HORN 20
  - KY CHG (Keyset Change) 64, 69
  - KY CLR (Erase Keys) 69
  - KY SEL (Key Select) 70
  - LOCK (Site Lock) 49
  - MON (Monitor) 12, 25
  - MSG (Message) 36, 45
  - OTAR (Rekey Request) 70
  - PHONE 34, 43, 44
  - PRI ED (Priority Edit) 31
  - Private Call 42
  - Private Call (SmartNet) 41
  - PUB AD (Public Address) 21
  - PW CHG (Set User Password) 13, 59
  - RESP (Call Response) 43
  - RTA (Repeater Talk-Around) 28
  - RWS (Radio Wide Scan) 22
  - RWS ED (RW Scan List Edit) 24
  - SCAN 21, 22, 30
  - SCN ED (Scan Edit) 23
  - SEARCH (Site Search) 49
  - SEL SQ (Normal/Selective) 26
  - SN LIST (Scan List Select) 48
  - SQ LIST (Squelch Select List) 27
  - STATUS 36, 45
  - SURVLC (Surveillance) 20
  - TG SEL (Talk Group Select) 33
  - TN VOL (Tone Volume) 19
  - TONE (Alert) 19
  - TX PWR (Transmit Power) 19
  - Option Switch Function Table 18
  - Option Switches 10, 19
  - Option Upgrading 55
  - Optional Features 55
  - OTAR 67
  - OTAR capabilities 69
  - OTAR Definitions 64
  - OTAR Messages Supported 69
- P**
- P25 Group calls 33
  - P25 Packet Data 36
  - P25 PTT ID 33
  - P25 Talk Group 33
  - Paging 35, 44
    - Answering 44
    - Answering (Conv P25) 35
    - Initiating 35, 45
  - Password
    - Changing 59
    - Download/Upload 58, 59
    - Master 58, 59
    - Power On 58, 59
    - Power-Up 13
    - User 58, 59
    - Zone 59
  - Penalty Timer 27
  - PID Mode 61, 62
  - Power On/Off 13
  - Power On-Off 13
  - Power Output Select 19
  - Power Turn-Off Delay 20
  - Power-Up Password 13
  - Priority Calls
    - Conv 30
  - Priority Channel
    - Changing 31
  - Priority Sampling
    - P25 Trunked 47
    - SMARTNET/SmartZone 47
  - Priv. Conversation II Calls
    - Placing 42
    - Receiving 43
  - Private (Unit-To-Unit) Calls 41
  - Programming 53
  - Project 25 Mode 16
  - PTT ID 41
  - PTT Switch 10
  - Public Address 20
- R**
- Radio Options Screen 56
  - Radio Set Identifier 67
  - Radio Wide Scanning 21
  - Receive Only 15
  - Red 67
  - Rekey 67
  - Repeater Talk-Around 28
  - RS-232 Port 36
  - RSI 67, 68
  - RW Scan List
    - Determining Channels in 24
    - Editing 24
- S**
- Scan List 21
    - Conventional Mode 29
    - Editing 23
    - Radio Wide Scan Mode 24
    - Selecting 23
    - Standard Scan Mode 23
  - Scanning
    - Conventional 29
    - Radio Wide 21
    - SMARTNET 47
    - Standard 21
  - Secure Communication 60
  - SecureNet 60
  - Select Switch 10
  - Servicing 54
  - Silent Mode 28
  - Site
    - Locking/Unlocking 49
    - Searching for 49
  - Site ID (SmartZone) 49
  - Site Trunking 49
  - SLN Mode 61, 62
  - SMARTNET/SmartZone Mode 16
  - Speaker 10
  - Speaking Into Microphone 54
  - Squelch Adjust 15
  - Squelch Code Select 27
  - Squelch Control 15, 39
  - Standard Calls
    - Placing (Conv) 32
    - Placing (SMARTNET) 40
    - Receiving (Conv) 32
    - Receiving (SMARTNET) 40
  - Standard Private Conversation
    - Mode 41
  - Status Display 12
  - Status Messages 36, 45
  - Storage Location Number 67
  - Supervisory Tones 51
  - Supported OTAR Messages 69
  - Surveillance Mode 20
  - SYS PARMS 37
  - Systems 17
- T**
- Tag 14
  - TEK 67
  - Telephone Calls
    - Receiving (SMARTNET) 44
  - Telephone Calls) 34
  - TG on Rx 41
  - Time, Scan Hold 22
  - Time-Out Timer 19
  - Tone Call Guard Squelch 26
  - Tone Select 19
  - Tones 51
  - Traffic Encryption Key 64, 67
  - Transmit Disable 15
  - Transmit Type 39
  - Transmitting, Scan Mode 22, 30
  - Troubleshooting 54
- U**
- UKEK 68
  - Unit Calls, Project 25 33
  - Unit ID, Project 25 32
  - Unit ID, SMARTNET/SmartZone 40
  - User Group ID 33, 41
- V**
- Voice Encryption 60
  - Volume Level 13
- W**
- Warranty 2
- Z**
- Zeroize 67
  - Zone 11, 14
  - Zone Password 37, 59
  - Zone/Channel Select 14
  - Zones 17



